

School of Engineering

2023

School of Engineering

— Creating new industries and advancing civilization —

Engineering contributes to civilization – the framework that guarantees the happiness of human being – and creates technologies that make human lives richer and more comfortable.

Message from the Dean



The School of Engineering is the largest educational and research organization in Tokyo Institute of Technology with more than 200 faculty members in five research fields of engineering: Mechanical Engineering, Systems and Control Engineering, Electrical and Electronic Engineering, Information and Communications Engineering, and Industrial Engineering and Economics, which are considered as the core fields of engineering. Through the innovative educational curricula established by the educational reform in 2016, we are fostering creative engineers, researchers, and educators who can play an active role globally, and promoting world-class research activities. This booklet provides a wide range of research fields in the

School of Engineering, and lists the research topics of each faculty member.

Regarding the composition of research fields, in order to meet the needs of society, the research fields in each department are divided into research groups, and the research groups are further subdivided into research fields consisting of small number of faculty members. In addition to this classification, there are four interdisciplinary research groups, the Smart Power Grid Group, the Integrated IoT Technology Group, the Human Centric Group, and the Super Bio Robotics Group in order to respond to global research issues such as the SDGs. Further more, in anticipation of the integration of our university and Tokyo Medical and Dental University, which is expected to take place in 2024, we are also strengthening research on medical-engineering collaboration. Through these research organizations, we will promote not only creative research by faculty members, but also collaboration research between industry and academia, and international joint research with some of the world's top universities and corporations.

Please look forward to the education and research of the School of Engineering that will contribute to the future society.

Kotaro Inoue
Dean, School of Engineering

Steering Committee

Hideaki Fujita, Associate Dean for Education

Daisuke Kurabayashi, Associate Dean for Finance and Campus Management

Akiyoshi Shioura, Associate Dean for Planning and Safety

Mamoru Tanahashi, Associate Dean for Research, International Affairs, and Public Relations

Atsushi Takahashi, Associate Dean for General Affairs and Human Resources

Wakaha Ogata, Associate Dean for Diversity

Departments and Research Groups in School of Engineering

Department	Graduate Major	Group	Field
Mechanical Engineering	Mechanical Engineering Energy Science and Engineering* Engineering Sciences and Design* Human Centered Science and Biomedical Engineering* Nuclear Engineering *	Nanosystems	Multiscience, Ultrahigh Precision Processing, Biomedical Fusion
		Human Centric Design	Robotics, Human-machine Interface, QOL Design, Medical Engineering
		Carbon Neutral	Energy, Environmental Thermofluid
		Aerospace Systems	Space Engineering, Aeronautical Engineering
		Advanced Solution	Simulation Engineering, Advanced Materials & Manufacturing, Intelligent Sensing, Advanced Designing
Systems and Control Engineering	Systems and Control Engineering Engineering Sciences and Design*	Control Theory	Intelligent Robot, Cyber Physical Systems, Complex Network Systems
		Advanced Measurement	Mechanical Design and Functional Evaluation, Computer Vision and Image Processing, Applied Measurement Using Acoustic and Radio Waves
		System Analysis	Nonlinear and Stochastic Dynamics, Computational Mechanics, Power Systems for Transportation
		System Integration	Bio-robot, AI-robotics
Electrical and Electronic Engineering	Electrical and Electronic Engineering Energy Science and Engineering* Human Centered Science and Biomedical Engineering* Nuclear Engineering*	Circuit	Integrated Circuit
		Photonics, Ultrasonics, and Communications	Wireless Communications, Informatics, Photonics, Ultrasonics
		Device	Compound Semiconductor Device, Quantum Functional Device, Intelligent Device, Terahertz Device, Green Device
		Electronic Materials	Energy Electronics, Spintronics, Nano- and Bio-photonics, Organic Electronics, Integrated Electronics, Bioelectronics
Information and Communications Engineering	Information and Communications Engineering Human Centered Science and Biomedical Engineering* Engineering Science and Design*	Electric Power and Energy	Electric Power System, Power Electronics, Electric Machinery, Plasma and Environment
		Human Information Systems	Sensory Information Processing, Intelligent Information Processing, Media Information Processing, Biological Information Processing
		Signal Processing	Media Signal Processing, Inverse Problems
		Communication, Networks, and Security	Communication Systems, Information Theory and Security
		Integrated Circuit and Computer	Digital Integrated Circuits, Analog Integrated Circuits
Industrial Engineering and Economics	Industrial Engineering and Economics Engineering Sciences and Design*	Integrated Information and Communications	Distributed Information and Advanced Communication Systems
		Advanced Management and Paradigm Creation	Industrial System, Human Centered System, Operations Management
		Analysis Method Creation	Mathematical Sciences and Informatics, Econometrics, Business Data Science
		Corporate System Creation	Corporate Governance System, Management Strategy/Marketing
		Economic Science	Macroeconomics/Clometrics, Microeconomics/Game Theory, Humanomics, Global Environmental Research

* interdisciplinary graduate majors that span multiple schools or departments

Interdisciplinary Research Groups	Integrated IoT	Super Smart Society System
		Cyber Physical System
		Smart Wireless Technology
		Quantum Science Innovation
	Human Centric	Human Centric Design
		Perceptual AI
		Humanomics
	Smart Power Grid	Cybernetics
		Electric Power Conversion
		Electro Mechanical Energy Conversion Field
		Renewable Power Generation
	Super Bio Robotics	Electric Power Control
		Electric Energy Storage
Algorithm and Control		
	Soft Robotics	
	Cyber Physical Sensing	

Interdisciplinary Research Groups

Mechanical Engineering

Systems and Control Engineering

Electrical and Electronic Engineering

Information and Communications Engineering

Industrial Engineering and Economics

Interdisciplinary Research Groups

Integrated IoT Group

Super smart society realized with IoT

In order to realize super smart society using IoT technology, we are conducting research activities with a department-transverse research group in the school of engineering.

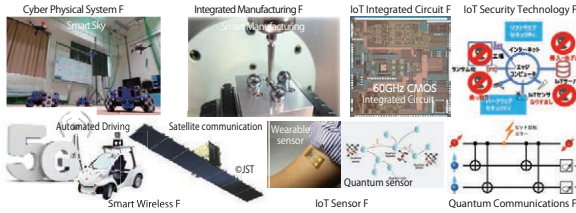

Jiang Zhu, Assistant Professor
Digital engineering, Intelligent manufacturing system, advanced machining and measurement system

Integrated IoT Group

Smart Wireless Technology Field



Jiro Hirokawa, Professor
Millimeter-wave high-efficiency planar antenna, 2D beam-switching circuit, fast analysis for antenna design, 2D orthogonal multiplexing



Takashi Tomura, Tenure-track Assistant Professor
Research based on electromagnetic engineering: small-satellite onboard antennas, Origami deployable membrane antennas, millimeter- & THz-wave-band antennas & material characterization



Kazuhiko Fukawa, Professor
Transmission and network techniques for wireless communications by developing digital signal processing, adaptive filters, and statistical based algorithms.

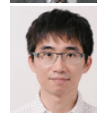

Yuyuan Chang, Assistant Professor
Mobile communication, millimeter-wave communication, MIMO system, MU-MIMO system, user scheduling, wireless sensor networks



Satoshi Suyama, Visiting Professor
Next generation mobile communication system/Radio access technologies/Radio Access Networks/Mobile Radio Applications



Kenichi Okada, Professor
Millimeter-wave Wireless Transceiver / 5G / Battery-less IoT Wireless Sensor Node / CMOS Integrated Circuits / PLL / Atomic Clock / Terahertz Communication & Sensing & Imaging



Atsushi Shirane, Associate Professor (FIRST)
5G, IoT, Satellite Communication, Wireless Communication, Wireless Power Transfer, RF fingerprint, Rad-Hard Transceiver

Faculty

Integrated IoT Group

Super Smart Society System Field



Kei Sakaguchi, Professor
Wireless communication engineering
B5G/loT/Millimeter-wave/Wireless energy transmission
Connected car/Automated driving



Tran Gia Khanh, Associate Professor
Gbps-class wireless backbone network, Radio resource management using AI, IoT networks employing drones



Teruya Fujii, Specially Appointed Professor
Wireless transmission technologies for the 6th mobile communication system / The 3D cell layout and network cooperation control / HAPS Cellular system / Cellular drone repeater system for disaster



Hideki Omote, Specially Appointed Associate Professor
6th mobile communication system / Radio propagation for the 6th mobile communication system and HAPS cellular system / International standardization of mobile radio propagation



Dai Taguchi, Associate Professor
Analysis of electrical and electronic materials, and novel electrical and optical techniques for probing these materials based on dielectric physics.



Hiroshi Sasaki, Associate Professor
Computer Architecture, Computer Security, Computer Systems, Internet of Things (IoT), Workload Characterization



Hideharu Takahashi, Associate Professor
Smart agriculture and forestry engineering, remote sensing, environmental recovery, utilization of unused resources, zero carbon energy



Koichi Suzumori, Professor
Development of new actuators and their application to biomimetic robots, soft robots, body support wears, tough robots and micro robots.



Hiroyuki Nabae, Assistant Professor
Study on component technologies with a focus on new actuators, and their application to micro robots and mechatronics devices



Takeshi Hatanaka, Associate Professor
Cyber-Physical-Human systems, Coordinated control of robotic networks Distributed control and decision for Smart Sky, Ocean, and Agriculture



Tomohisa Tanaka, Associate Professor
Development of new production technologies by using high frequency vibration and laser energy, development of practical devices with additive manufacturing technology

Integrated IoT Group

Quantum Science Innovation Field



Mutsuko Hatano, Professor
Quantum sensors and power devices using widegap semiconductors, Developing wide-field technologies from materials to systems for energy and medical applications



Takayuki Iwasaki, Associate Professor
Quantum sensing and quantum emitter using atomic-scale structures in diamond toward next-generation low-loss power devices and biological/medical applications



Keigo Arai, Associate Professor
Quantum informatics
Quantum transformation
Next-generation IoT and green technology



Ryutaroh Matsumoto, Professor
Quantum information
Quantum transformation
Next-generation IoT and green technology



Tadashi Sakai, Specially Appointed Professor
Research on synthesis of carbon-based materials (diamond, graphene, CNT, etc.) and their application to devices (quantum sensors, electron sources, interconnects, power devices) / International standardization of nanoelectronic material and product technologies



Naota Sekiguchi, Specially Appointed Assistant Professor
Developing precision magnetometer using nitrogen-vacancy centers in diamond towards measurement of biomagnetic field.

Interdisciplinary Research Groups

Human Centric Group

Human centric engineering

We are working to create and develop the field of Human centric engineering from the various points of view, such as design, humanomics, human information processing, cybernetics.

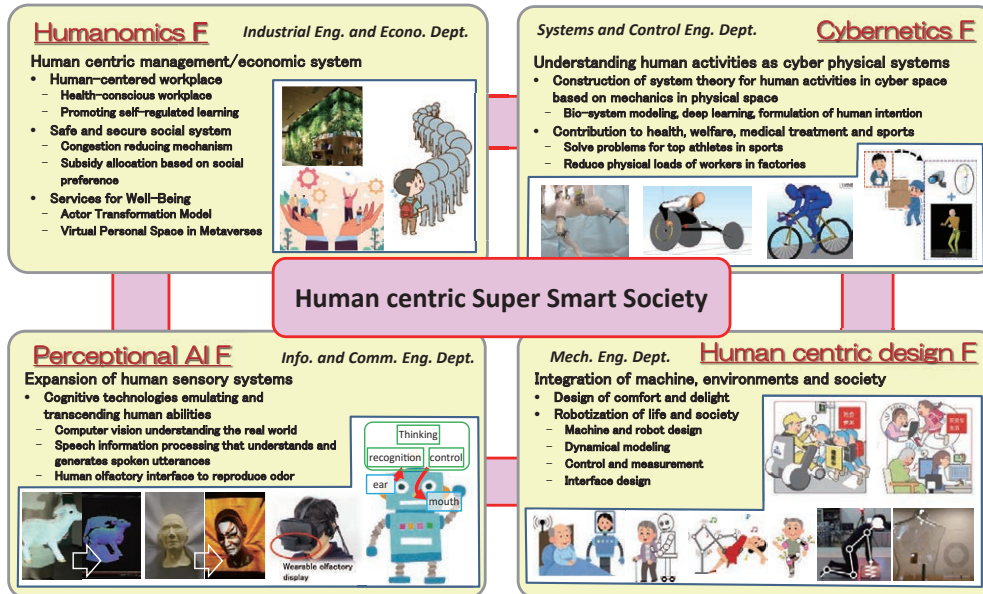

Faculty

Human Centric Group

Human Centric Design Field



Masafumi Okada, Professor
Robot design and control from mathematical or physical point of view, and its application to human motion instruction.



Motoki Shino, Professor
Our research focuses on Wellbeing Science and Assistive Technology for improving the quality of human life. To ensure the mobility and usability of human beings, we thoroughly analyze human-machine interaction and design advanced human-machine interfaces.



Yoshifumi Nishida, Professor
Methodology on observing daily behavior of persons who faces the physical and cognitive changes, and designing a daily life system that enables to maintain quality of life based on data-driven ergonomics and statistical mathematics.



Yusuke Sugahara, Associate Professor
Mechanism, design and control of robots and mechanical systems. Bipedwalking vehicle, stair-climbing wheelchair, Aero-Train, human-poweredrobotics, cable-driven parallel robots, mechanism of mobile robots.



Wataru Hijikata, Associate Professor
Study on medical device and mechanical system based on mechatronics and biomedical engineering. Development of implantable power generator, artificial heart, wireless power transfer, control of muscle contraction.



Yuki Hashimoto, Assistant Professor
Research on elemental technologies, mainly new sensors, that will solve social problems related to medical and health care, and R&D of new monitoring device systems that integrate the above technologies with the IoT

Human Centric Group

Perceptual AI Field



Takamichi Nakamoto, Professor (FIRST)
Human Olfactory Interface/Olfactory Display/Odor Sensing System/Sensory Information Processing/Embedded System/Biomimetic Sensing System



Takahiro Shinozaki, Associate Professor
Speech recognition and understanding, Speech and Language Processing, Machine learning



Yoshihiro Watanabe, Associate Professor
Computer vision, Augmented reality, Visual display, Digital archiving, Human computer interaction

Human Centric Group

Humanomics Field



Dai Senoo, Professor
Theory of Organization, Strategy, Knowledge Management and Information Systems. Main projects are Creative Office, Open Innovation and Business Ecosystem.



Emiko Fukuda, Associate Professor
Industrial economics/experimental economics/numerical analysis of game theory model/congestion management/security and disaster-relief service

Human Centric Group

Cybernetics Field



Motomu Nakashima, Professor
Modeling of human motion in sports, optimization of human motion as well as design and development of optimal tools and equipment using simulation and humanoid robot



Akisue Kuramoto, Assistant Professor
Biomechanical analysis of worker posture/Anomaly detection in work movement/Optimal work environment design/Biological measurement/Surrounding environment recognition technology for transportation systems

Interdisciplinary Research Groups

Smart Power Grid Group

Advanced usage of renewable energy

To accelerate the advanced usage of renewable energy based on the research and development on distributed and cooperative control with a core of power electronics and secondary batteries, the School of Engineering organizes Smart Power Grid Group beyond the framework of Departments, and various research activities are conducted.

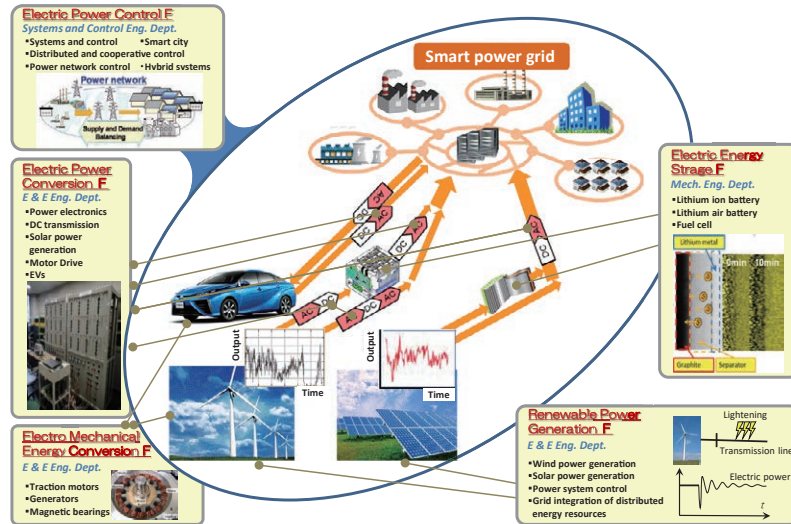

Faculty

Smart Power Grid Group

Electric Power Conversion Field



Hideaki Fujita, Professor

Power electronics, Electric machinery, Photovoltaic inverters, Micro hydropower generation



Makoto Hagiwara, Associate Professor

Application of power electronics to next-generation electric power systems, battery energy storage systems, electric vehicles and renewable energies.



Kenichiro Sano, Tenure-track Assistant Professor

Power electronics in electric power systems: High voltage DC transmission for offshore wind farms, transient analysis of power systems, power qualities in distribution systems

Smart Power Grid Group

Electro Mechanical Energy Conversion Field



Akira Chiba, Professor

Power Mechatronics and Intelligent Drive: Bearingless motor drive with integrated motor and magnetic bearing functions. Switched reluctance motors for high efficiency and compactness for EV, hybride vehicles, and next generation automobiles.



Kyohei Kiyota, Associate Professor

Electric machinery/Mechatronics/Rare-earth Free Motors/Reluctance motors/Motors for vehicles/Bearingless motors/Magnetic bearing



Yusuke Fujii, Assistant Professor

Electric machinery/power electronics/control theory/magnetic suspension/ motor drive

Smart Power Grid Group

Renewable Power Generation Field



Kenichi Kawabe, Tenure-track Assistant Professor

Power system engineering/Power engineering/Wind power/Photovoltaic power/Energy storage/Power electronics-based devices/Mathematical Programming

Smart Power Grid Group

Electric Power Control Field



Jun-ichi Imura, Professor

Control theory of harmonized power systems accepting massive renewable energy of photovoltaic/wind power, Design theory of global power systems with power markets



Takayuki Ishizaki, Associate Professor

Distributed power systems stabilization based on retrofit control and electricity market design under high penetration of storage and renewable energy resources



Hampei Sasahara, Assistant Professor

Hierarchical global power system control theory/Mathematical analysis of cybersecurity and privacy in smart grids/Design of demand response via game theory

Smart Power Grid Group

Electric Energy Storage Field



Shuichiro Hirai, Professor

X-ray, MR In-situ measurements and numerical simulations of fuel cell, lithium battery, lithium air battery, etc.



Takashi Sasabe, Associate Professor

In-situ X-ray imaging/reaction and transport simulation of fuel cell, Liion batteries and electrolysis, Development of high performance electrode by controlling dispersion structure of slurry



Manabu Kodama, Tenure-track Assistant Professor

Operando X-ray CT Internal Structure Measurement of Fuel Cell and All Solid-state lithium-ion Battery. Study of High Efficiency Energy Conversion with Multi-physics (Electrochemistry-Thermodynamics-Two phase flow) Large Scale Numerical Simulation.

Interdisciplinary Research Groups

Super Bio Robotics Group

Creation of next-generation robot technology

By evolving sensing, actuators, and algorithms, we aim to create next-generation robots that surpass living organisms, and break through issues that were unsolved by conventional technology.

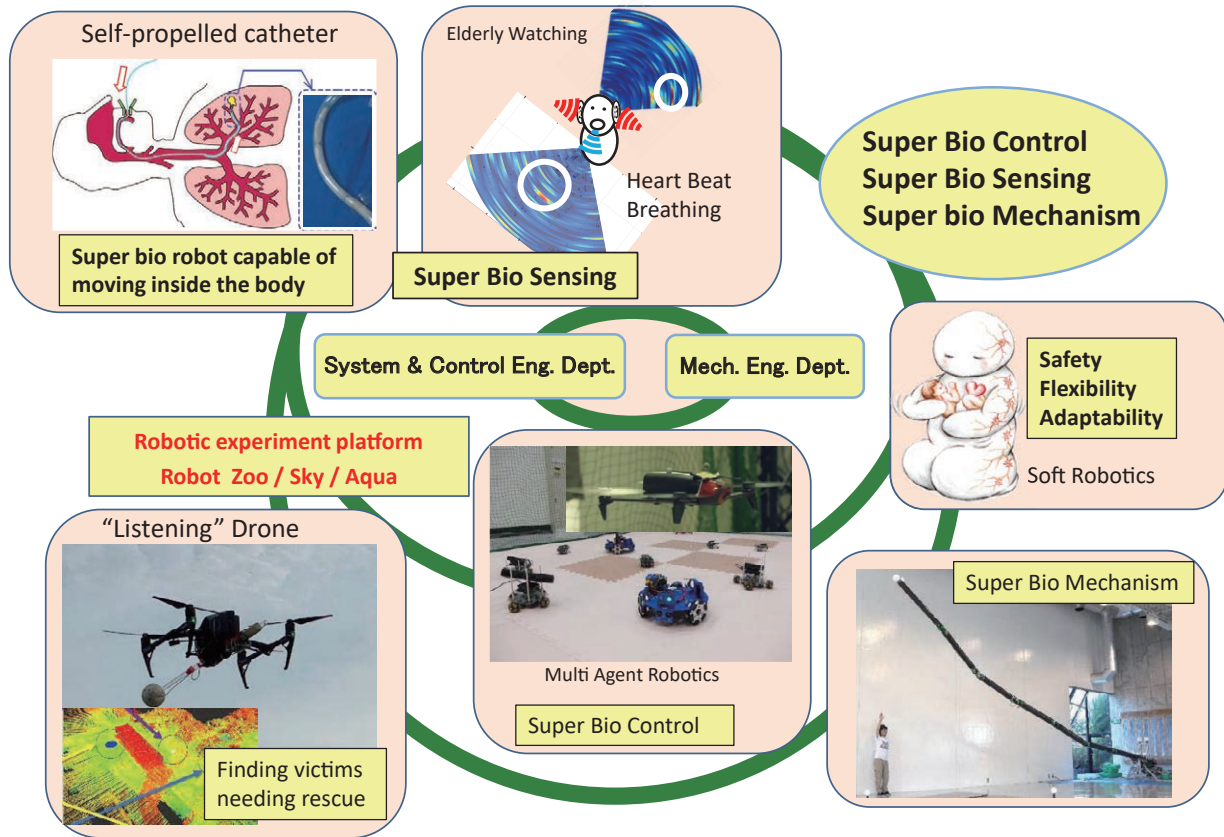

Faculty

Super Bio Robotics Group

Algorithm and Control Field



Daisuke Kurabayashi, Professor
Analysis of Adaptive Behavior by using Bio-machine Hybrid Systems, Integration of Distributed Autonomous Robotic Systems, Motion and Path Planning for Robotic Systems



Hideyuki Tsukagoshi, Professor
Study on fluid powered actuators referring to the muscular structure and the working principle of creatures, and their application to medical robot and rescue.

Super Bio Robotics Group

Soft Robotics Field



Koichi Suzumori, Professor
Development of new actuators and their application to biomimetic robots, soft robots, body support wears, tough robots and micro robots.



Gen Endo, Professor
Design and development of practical robot and mechanical system. Study on mobile robot, decommissioning robot, super redundant manipulator, tendon-driven robot, welfare robot.

Super Bio Robotics Group

Cyber Physical Sensing Field



Shinji Ohyama, Associate Professor
Measurement technology such as new localization system for sensor networks, CT system for visualization of temperature and wind speed distribution



Masayuki Tanaka, Professor
Image Analysis, Multispectral Imaging, Multi-Modal Image Fusion, Image Processing Based on Generative Model, Optimization and Machine Learning.



Kazuhiro Nakadai, Professor
Key research topics are robot audition and computational scene analysis, and wide areas are covered such as robotics, signal and speech processing, AI, and machine learning.



Kotaro Hoshiba, Assistant Professor
Surrounding environment recognition by sound / Computational auditory scene analysis / Acoustic measurement / Acoustic signal processing / Robot audition / Drone audition / Rescue robot / Ultrasonics.

Department of Mechanical Engineering

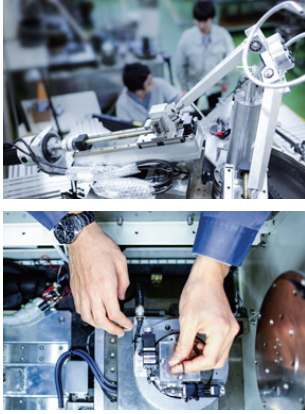

Education and research at the Department of Mechanical Engineering is designed to discover new phenomena, principles, and methods and to create new machinery capable of achieving a balance between humanity and the environment.

Students at the Department of Mechanical Engineering acquire advanced, specialized knowledge in the field of mechanical engineering and much more. By teaching students how to identify and solve problems, and by instilling in them the abilities they need to communicate with people around the world, our aim is to cultivate individuals who will be active in industry and academia, and contribute to maintaining and improving Japan's competitiveness on the global stage into the future. In the excellent education and research environment, discover your own potential alongside faculty who work on the frontier of mechanical engineering.



Hirotsugu Inoue
Department Chair

Research

The Department of Mechanical Engineering is actively working toward expanding the fundamental areas of study and research in the field of mechanical engineering. The department is building an educational/research framework that thoroughly displays the strengths of mechanical engineering as an integrated technological field, thereby contributing to the advancement of research into advanced energy applications, advanced functional materials, digital manufacturing, and other such areas. In addition, we are producing outstanding results in the fields of robotics and advanced manufacturing technologies, both of which share strong ties with industry, and are putting forth great effort in frontier fields such as aerospace and medical engineering. Moreover, we promote safe, secure technological development from a mechanical engineering viewpoint, as we conduct research and development aimed at achieving human-centric design. In terms of collaboration with society, our department provides opportunities to meet faculty members conducting various types of research with support by the Industry-University Cooperation Office in the School of Engineering, and then contributes to the creation of useful mechanical engineering for society.

Education

The Department of Mechanical Engineering offers courses such as Engineering Mechanics, Mechanics of Materials, Thermodynamics, Fundamentals of Fluid Mechanics, Mechanical vibrations, and Machine Elements and Machine Drawing. Through courses like these, student learn how to analyze the behavior of mechanical systems, and gain the knowledge they need to integrate that understanding into the creation of new mechanisms. In addition to these disciplines, which serve as the core of mechanical engineering, students set their sights on a broad array of research fields, including control, robotics and mechatronics; precision engineering; mechanical design; processing, production and materials; biomedical and welfare engineering; design engineering; space engineering and more. Students learn not only how to analyze various phenomena theoretically; they also learn how to apply that knowledge to solve issues that arise in engineering. Our aim is to cultivate individuals capable of devising innovative mechanical systems that will help humanity achieve balance with its environment.

In addition to the undergraduate program, the department offers graduate programs in Mechanical Engineering, Energy Science and Engineering, Engineering Sciences and Design, Human Centered Science and Biomedical Engineering, and Nuclear Engineering.

Research Groups and Fields of Research

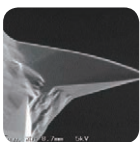

Nanosystems Group

Evolve nanotechnologies broadly
Multiscience Field, Ultrahigh Precision Processing Field, Biomedical Fusion Field



Carbon Neutral Group

Combine wisdoms for energy and environment
Energy Field, Environmental Thermofluid Field



Advanced Solution Group

Make the most of engineering knowledge
Simulation Engineering Field, Advanced Materials & Manufacturing Field, Intelligent Sensing Field, Advanced Designing Field



Human Centric Design Group

Design comforts and delights
Robotics Field, Human-machine Interface Field, QOL Design Field, Medical Engineering Field



Aerospace Systems Group

Explore the frontiers of sky and space
Space Engineering Field, Aeronautical Engineering Field



Faculty

ZC: Laboratory for Zero-Carbon Energy MSL: Laboratory for Materials and Structures
 FIRST: Laboratory for Future Interdisciplinary Research of Science and Technology
 GSIC: Global Scientific Information and Computing Center

Nanosystems Group

Multiscience Field



Tomohiro Nozaki, Professor
 Plasma engineering, Electron-driven catalysis, Carbon dioxide utilization technology, Hydrogen energy/Low-carbon technology, Process simulation, etc.



Kazuyoshi Fushinobu, Professor
 Thermal/energy phenomena, from fundamental to applications. Laser processing, Electronic packaging, Digital Printing, Energy Equipment. Strong ties with industries.



Yoichi Murakami, Professor (ZC)
 CO₂absorption/adsorption materials, CO₂separation system with flow, photon upconversion, thermal energy harvesting, materials for solid batteries.



Masami Kadonaga, Specially Appointed Professor
 Fundamental research and simulation of evaporation/penetration/drying/dot-formation for inkjet printing.



Koichi Kato, Specially Appointed Associate Professor(Lecturer)
 Fundamental research and simulation of evaporation/penetration/drying/dot-formation for inkjet printing.



Dae-Yeong Kim, Assistant Professor
 Electrification / Low-carbon technology / Plasma catalysis / Synthesis of carbon materials / Secondary batteries, etc.

Nanosystems Group

Ultrahigh Precision Processing Field



Atushi Hirata, Professor
 Ultraprecision polishing, coating, laser processing, tribology and material characterization with micro/nano materials for surface function design.



Masahiko Yoshino, Professor
 Nano/micro Manufacturing, Metalforming, Machining Development of functional materials /surfaces.



Yuko Aono, Associate Professor
 Laser modification of mechanical and chemical property, Digital manufacturing with shape and function design, Fabrication and application of functional film.



Daijiro Tokunaga, Assistant Professor
 Control method and application development of internal modification of transparent materials induced by laser/Ultrashort-pulsed laser/Fiber fuse/shape processing of hard and brittle materials

Nanosystems Group

Biomedical Fusion Field



Toru Omata, Professor
 Surgical robots for minimally invasive surgery and cell culture devices for cancer study, etc. using microfluidic technology.



Joon-wan Kim, Professor (FIRST)
 Micro hydraulic pressure sources integrating MEMS technology with Electro-conjugate fluid (ECF) and its application systems.



Takeshi Hatsuzawa, Professor (FIRST)
 MEMS/NEMS application and development to bio-assay and diagnosis devices by interdisciplinary technology including mechanical and bio engineering.



Yasuko Yanagida, Professor (FIRST)
 Development of MEMS/NEMS and bioMEMS devices applied for bioscience, medical engineering and environmental analysis.



Kazuhiro Yoshida, Professor (FIRST)
 Development of innovative mechano-devices/systems such as new actuator systems for advanced soft microrobots that perform power-needed tasks in micro space.



Tadashi Ishida, Associate Professor
 Biomicrofluidic devices for drug discovery and medical applications by the combination of nano/micro technologies and cellular characteristics.



Takasi Nisisako, Associate Professor (FIRST)
 Innovative nano- and microfluidics for Lab-on-a-Chip applications and functional materials production, and their industrialization.



Takatoki Yamamoto, Associate Professor
 Micro/nanodevices fabricated by microfabrication, mainly for life science applications. Micro/nano engineering, Lab-on-a-chip, biomimetics, etc.



Yusuke Kanno, Assistant Professor (FIRST)
 Research on micro/nano devices for biochemical analysis and advanced materials production.



Tetsuya Yamada, Assistant Professor (FIRST)
 MEMS biosensor/Artificial cell membrane/Electromicrobiology/Photocatalyst/Nanoparticles.

Human Centric Design Group

Robotics Field



Gen Endo, Professor
 Design and development of practical robot and mechanical system. Study on mobile robot, decommissioning robot, super redundant manipulator, tendon-driven robot, welfare robot.



Koichi Suzumori, Professor
 Development of new actuators and their application to biomimetic robots, soft robots, body support wears, tough robots and micro robots.



Yukio Takeda, Professor
 Mechanical systems design, kinematics, mechanisms, machine elements, robotics, industrial robot, assistive device.



Shingo Maeda, Professor
 Soft Material, Soft Robotics, Chemomechanical system



Hiroshi Nakamura, Specially Appointed Professor
 Lightweight actuators for future collaborative robots/Mechatronics/Motion control



Yusuke Sugahara, Associate Professor
 Mechanism, design and control of robots and mechanical systems. Biped walking vehicle, stair-climbing wheelchair, Aero-Train, human-powered robotics, cable-driven parallel robots, mechanism of mobile robots.



Hiroto Tanaka, Associate Professor
 Biomechanics and fluid dynamics of swimming/flying animals. Bioinspired swimming/flying robots.



Mitsuru Endo, Specially Appointed Associate Professor
 Human Collaborative Robot, Lightweight Actuator, Mechatronics.

Interdisciplinary Research Groups

Mechanical Engineering

Systems and Control Engineering

Electrical and Electronic Engineering

Information and Communications Engineering

Industrial Engineering and Economics



Ming Jiang, Assistant Professor

Assistive device, Robotics, Machine element design, Biomedical engineering, Optimal design



Hiroyuki Nabae, Assistant Professor

Study on component technologies with a focus on new actuators, and their application to micro robots and mechatronics devices.

Human Centric Design Group

Human-machine Interface Field



Tohru Yagi, Professor

Our goal is to understand the neural mechanisms, and to exploit its findings in biomedical engineering applications, e.g. neural interfaces.



Takako Yoshida, Associate Professor

Brain science, human perception and psychophysics, visuo-haptic multimodal man-machine interface, attention/inattention.



Satoshi Miura, Associate Professor (Lecturer)

Human-Machine Interface/Brain-Machine Interface/VR AR/AI/Surgical Robotics/Medical Robotics/Welfare Robotics.

Human Centric Design Group

QOL Design Field



Masafumi Okada, Professor

Robot design and control from mathematical or physical point of view, and its application to human motion instruction.



Shigeki Saito, Professor

Robotics based on Micro-mechanics, adhesional device by bio-inspired structure, creativity in engineering design.



Motoki Shino, Professor

Our research focuses on Wellbeing Science and Assistive Technology for improving the quality of human life. To ensure the mobility and usability of human beings, we thoroughly analyze human-machine interaction and design advanced human-machine interfaces.



Yoshifumi Nishida, Professor

Methodology on observing daily behavior of persons who faces the physical and cognitive changes, and designing a daily life system that enables to maintain quality of life based on data-driven ergonomics and statistical mathematics.

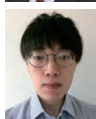

Yuki Hashimoto, Assistant Professor

Research on elemental technologies, mainly new sensors, that will solve social problems related to medical and health care, and R&D of new monitoring device systems that integrate the above technologies with the IoT

Human Centric Design Group

Medical Engineering Field



Tadahiko Shinshi, Professor (FIRST)

Medical mechatronics and micro/nano mechatronics based on magnetic force control.



Toshio Takayama, Associate Professor

Robot hands mechanism, Soft material based mobile devices and actuators, Mechatronics for medical devices, Microdevices for cell culture.



Kotaro Tadano, Associate Professor (FIRST)

Research and development of surgical robots for laparoscopic surgery, vitreous surgery and plastic surgery, human-machine interfaces and pneumatic systems.



Wataru Hijikata, Associate Professor

Study on medical device and mechanical system based on mechatronics and biomedical engineering, development of implantable power generator, artificial heart, wireless power transfer, control of muscle contraction.



Naohiro Sugita, Assistant Professor (FIRST)

Bubble dynamics/Medical ultrasound/Control of acoustic cavitation bubbles/Vibration measurement of ultrasound contrast agents (microbubbles)/Transdermal drug delivery

Carbon Neutral Group

Energy Field



Yoshihiro Okuno, Professor

Applications of magnetohydrodynamic technology, especially a high efficient MHD electrical power generation with non-equilibrium plasma flow.



Mamoru Tanahashi, Professor

Physics and modeling of turbulence, turbulent heat/mass transfer and turbulent combustion in gas turbine combustors and internal combustion engines.



Katsunori Hanamura, Professor

Near-field radiation transfer and its application to power generation, analysis of anode for high power density SOFC, and development of DPF for next generation.



Shuichiro Hirai, Professor

X-ray, MR In-situ measurements and numerical simulations of fuel cell, lithium battery, lithium air battery, etc.



Takashi Sasabe, Associate Professor

In-situ X-ray imaging/reaction and transport simulation of fuel cell, Li-ion batteries and electrolysis, Development of high performance electrode by controlling dispersion structure of slurry.



Masayasu Shimura, Visiting Associate Professor

Investigation of turbulent flow and combustion in gas turbine and internal combustion engines using laser diagnostics and simulations. Development of combustion control methods.



Manabu Kodama, Tenure-track Assistant Professor

Analysis of all solid-state batteries using X-rays, Research on high-efficiency energy conversion using multiphysics simulation, Advanced analysis using machine learning



Tsutomu Hozumi, Assistant Professor

Study on active control methods of supercooling and measurements of thermal properties for cold reserving materials, heat storage materials and foods.

Carbon Neutral Group

Environmental Thermofluid Field



Tetsuji Okamura, Professor

Research on refrigeration and cooling technologies, such as the development of cooling systems for superconducting magnets and superconducting devices, and the development of room-temperature magnetic refrigerators.



Takushi Saito, Professor (FIRST)

Development of thermal design technology for electrification of construction machinery, analysis of transport phenomena including interface, development of heat transfer control technology using nanomaterials



Tetsuya Suekane, Professor

Study on multiphase flows in porous media in geological storage of carbon dioxide and enhanced oil recovery based on X-ray microtomography and digital rock physics.



Sayaka Suzuki, Associate Professor

Fundamental research on fire phenomena through thermal engineering, evaluation of environmental effects of fires, development of environmentally-friendly strategies to prevent fires



Jun Hasegawa, Associate Professor (ZC)
Fundamental researches on generation of high-brightness quantum beams composed of ions, clusters, neutrons, or EUV light, and their applications in the field of fusion energy.



Tatsuya Kawaguchi, Assistant Professor
Experimental and numerical investigation of multiphase and transport phenomena and their interaction by means of the optical techniques.



Yuji Suzuki, Assistant Professor
Research and development of heat transfer devices based on the heat pipe technology for the thermal control of space equipment and so on.



Shintaro Matsushita, Assistant Professor
Development of practical numerical models to achieve high-resolution multi-phase flow simulation, and elucidation of fluid phenomena by numerical simulation that combines surface science such as surfactant effect and viscoelastic effect.

Aerospace Systems Group Space Engineering Field



Takanori Iwata, Visiting Professor
Guidance, navigation, control & dynamics of aerospace systems (e.g. spacecraft attitude & orbit control systems, estimation systems, components), spacecraft design, and project management/systems engineering.



Satoru Ozawa, Visiting Professor
Satellite system (communications satellite / earth observation satellite), design, analysis and verification of large deployable reflector, nonlinear finite element method, flexible multibody structural analysis, synthetic aperture radar, flight software, FPGA.



Hiraku Sakamoto, Associate Professor
Through investigating dynamic structural analysis methods for lightweight and flexible structures, we aim at generating innovative space structure systems.



Hiroki Nakanishi, Associate Professor
Research on mechanism, dynamics, and control for advanced space systems including space robotics, orbital service, astronaut support, and micro/nano satellites.



Yasutaka Satou, Visiting Associate Professor
Development, design, testing and verification of spacecraft structures and mechanisms, deployable space structures, and structural and mechanical technologies such as landing and drilling to realize exploration



Atsushi Noda, Visiting Associate Professor
Planning & research for next space system, small satellite and space robot, and its technology roadmap development.



Toshihiro Chujo, Tenure-track Assistant Professor
Astrodynamics, Trajectory design, Guidance, Navigation, and Control, Deep space mission design, Spacecraft system, Solar sail, Dynamics simulation.

Aerospace Systems Group Aeronautical Engineering Field



Takayoshi Inoue, Professor
Heat transfer and its control under the extreme conditions, such as ultra low temp., high temp., nanoscale, zero gravity field, strong centrifugal force field.



Akira Todoroki, Professor
Mechanics of materials and mechanics of composite materials; new fabrication process of composites and novel products of 3D printed composites.

Advanced Solution Group Simulation Engineering Field



Takayuki Aoki, Professor (GSIC)
Challenge to exa-scale simulation of gas-liquid and solid-gas-liquid multiphase flows by means of GPU-accelerated supercomputers.



Feng Xiao, Professor
Computational fluid dynamics, high-fidelity numerical methods for various complex flows, development of practical numerical models for real-case applications.



Ryo Onishi, Associate Professor (GSIC)
Integrated technologies of simulation and processing for utilizing the environmental Big Data/Numerical simulations of environmental multi-phase turbulence.



Yoshiro Suzuki, Assistant Professor
Artificial intelligence, deep learning, medical imaging, structural optimization, and composite material.

Advanced Solution Group Advanced Materials & Manufacturing Field



Wakako Araki, Professor
Mechanics of materials, Fracture mechanics, Solid state ionics, Mechanics and ionics of ion-conducting oxides



Naoto Ohtake, Professor (FIRST)
Main field of interest is materials processing and technology, including plastic forming, fabrication of hard carbon films and their application to industrial uses.



Chiaki Sato, Professor (FIRST)
Research on the mechanical aspects of carbon fiber reinforced composite material (CFRP) and adhesively bonded joints between CFRP and dissimilar materials frequently used for transportation such as automobiles and aircraft.



Hayato Yoshioka, Visiting Professor (FIRST)
Research on Nano-machining and Nano-measurement technologies based on originally developed precision mechanical elements and controllers.



Hiroki Akasaka, Associate Professor
Main research field is carbon and related materials. Related keywords are thin film engineering, material science and engineering, materials analysis, inorganic carbon materials.



Masatoshi Kondo, Associate professor (ZC)
Fusion reactor engineering, Fast reactor engineering, Seawater desalination, Seawater resource, Resource recycling, Low melting point metal, Liquid metal coolant, Material compatibility, Additive manufacturing



Motoki Sakaguchi, Associate Professor
Research in mechanics of materials, especially focusing on deformation and fracture of high temperature materials for jet engine application.



Tomohisa Tanaka, Associate Professor
Development of new production technologies by using high-frequency vibration and laser energy. Development of practical devices with additive manufacturing technology.



Takahisa Yamazaki, Associate Professor
Joining by various heating source, dissimilar materials like carbon based materials and heat resistant metals are joined using advanced material filler based on the change of interfacial energy in joining process.



Jiang Zhu, Assistant Professor
Development of new technology for freeform surface machining and measurement, digital manufacturing and intelligent manufacturing.

**Yu Sekiguchi, Assistant Professor (MSL)**

Design, strength evaluation and strength improvement of adhesively bonded joints, especially reversible adhesives mimicking gecko.

**Shingo Tajima, Assistant Professor (FIRST)**

Research on optimal trajectory generation for high-speed and high-precision control with multi-axis and robot machining

**Yuki Hirata, Assistant Professor (FIRST)**

Synthesis and evaluation of amorphous carbon film by plasma process / Elucidation of coating mechanism by numerical simulation and control its properties

Advanced Solution Group

Intelligent Sensing Field

**Hirotsugu Inoue, Professor**

Research topics in the field of mechanics of materials: non-destructive testing (infra-red thermography, ultrasonic), impact problem, and inverse analysis.

**Yoshihiro Mizutani, Associate Professor**

Non-destructive testing, structural health monitoring/evaluation/control for aerospace vehicles, chemical/power plants, automobiles and large construction machines. Application of AI to the above issues.

**Yu Kurokawa, Assistant Professor**

Non-destructive evaluation and flaw size measurement by ultrasonic testing. Flaw evaluation, stress analysis, and fatigue limit evaluation by infrared thermography.

**Kotaro Hoshiba, Assistant Professor**

Surrounding environment recognition by sound / Computational auditory scene analysis / Acoustic measurement / Acoustic signal processing / Robot audition / Drone audition / Rescue robot / Ultrasonics.

Advanced Solution Group

Advanced Designing Field

**Nobuyuki Iwatsuki, Professor**

Kinematics and dynamics of robotic mechanisms, functional material actuator, estimation of machinery noise and structural optimization to reduce noise.

**Hiroki Takahara, Professor**

Focusing on the mechanism of vibration, we conduct research on the nonlinear vibration of fluid-related vibration, dynamics of uncertain systems, etc. We aim at improving the function, reliability and safety of mechanical structures.

**Hiroshi Yamaura, Professor**

Research on dynamics, control and tribology of machinery for construction machinery, earthmoving machinery, vehicles, rover, mechatronics equipment, etc.

**Tsune Kobayashi, Specially Appointed Professor**

Analysis and design of contact and deformation condition of mechanical elements such as gears, screws and so on, development of drive-train system of automotive vehicles.

**Kazuaki Inaba, Associate Professor**

Research and design of various scale machines and structures from viewpoints of mechanics and material sciences; e.g., composites, automobiles, and power plants.

**Hiroshige Kikura, Associate Professor (ZC)**

For safety improvement and advancement of nuclear reactors, we are researching thermal hydraulics, fluid measurement, nuclear safety, robot remote measurement.

**Hideharu Takahashi, Associate Professor**

Smart agriculture and forestry engineering, remote sensing, environmental recovery, utilization of unused resources, zero carbon energy

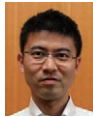
**Yutaka Nakano, Associate Professor**

We are studying the generation mechanisms of self-excite vibrations and their suppression (e.g. friction vibration, chatter, and so on).

**Shinji Tanaka, Specially Appointed Associate Professor (FIRST)**

Tribological technologies for hydraulic equipment of construction machinery, such as visualization of lubrication condition of real machine, lubrication analysis, evaluation of sliding characteristics of sliding materials and lubricants.

**Daisuke Matsuura, Specially Appointed Associate Professor**

Analysis and design of mechanical elements, robotics, mechatronics, visual measurement and servoing, noncontact manipulation and welfare device development.

Department of Systems and Control Engineering

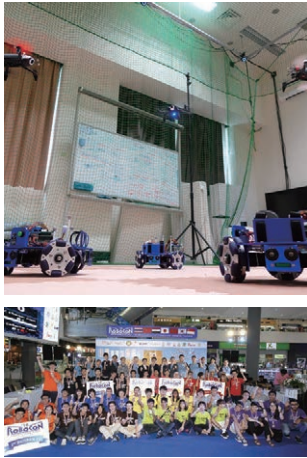

Unify the real world (physical) and information (cyber) as one system to create new values for future society.

Our modern life is supported by a huge number of complex artificial systems. To design valuable systems, we need to understand their dynamical properties so that they will safely work and surely satisfy our requirements. The Department of Systems and Control Engineering provides courses that offer insights into a variety of systems, which enable us to predict and control their dynamics. Our interests include not only artificial systems, e.g., robots, cars, planes, medical systems, and intelligent systems, but even life, society, and nature. The Department of Systems and Control Engineering prepares students to become creative and innovative individuals who can make beneficial contributions to our society.



Motomu Nakashima
Department Chair

Research

System control, used to measure, analyze, and control various phenomena, is essential in many fields in modern society including those in industry. A wide variety of technologies and techniques are required to design. Mathematical models take important roles in clarifying system structures so that we know dynamical properties of them. Control theory provides systematic design of control and measurement functions. We also need to find appropriate measurement methods, communication protocols, information processing, actuators, sensors, micro-controllers, and ways of integration. We have formed research groups and are conducting high level researches so that we achieve the ability to innovate novel systems to bring values into our society.

The department's primary fields of research are as follows: systems control theory, network control, precision mechanical instrumentation, sensing theory, computer vision, image processing, wave application instrumentation, chaotic vibrations, stochastic dynamics, nonlinear dynamics, inverse analysis, smart power grids, biomechanics, biorobotics, combustion engines, combustion control, exhaust treatment, autonomous systems, signal processing, artificial intelligence, intelligent robots, rescue robots, and radiation biology.

Education

In the Department of Systems and Control Engineering, we foster the basic ability necessary to objectively analyze everything — concrete and abstract — in nature and society as a system and to create new systems of value based on this knowledge. Students gain scholastic abilities in measurement, control, design, and system science as well as in areas such as machines, electricity, and information. We cultivate in our students flexible, creative thinking they need to construct systems that offer new value through many unique educational initiatives that focus on the importance of projects and practical learning. Students can take classes in which they participate in robot contests, and classes through which they form teams to examine societal needs and to build systems that tackle those issues. Students proceed to research works in specific issues conducted at affiliated laboratories, and through their master's thesis research they will acquire the technological and organizational skills needed to develop new systems. They learn not only research protocols and methods but also ethical attitudes to be responsible engineers contributing to make a better future.

Undergraduate programs

- * School of Engineering
- * Department of Systems and Control Engineering

Graduate programs

- * Systems and Control Engineering
- * Engineering Sciences and Design

Research Groups and Fields of Research

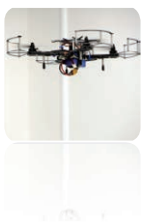

Control Theory Group

Researching cutting-edge systems theory targeting various systems, from next-generation robots to smart cities

- Intelligent Robot Field
- Cyber Physical Systems Field
- Complex Network Systems Field



System Analysis Group

Using mathematical approaches to analyze systems both natural and artificial, and research methods that allow for deeper quantitative and qualitative understanding of their behavior

- Nonlinear and Stochastic Dynamics Field
- Computational Mechanics Field
- Power Systems for Transportation Field

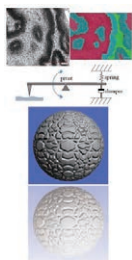

Advanced Measurement Group

Researching cutting-edge measurement technologies that allow observation of objects both visible and invisible, to gain an understanding of various phenomena found in our world

- Mechanical Design and Functional Evaluation Field
- Computer Vision and Image Processing Field
- Applied Measurement Using Acoustic and Radio Waves Field



System Integration Group

Realizing future robot systems based on various approaches, such as sports engineering, speech recognition, machine learning and biomimetics, in order to bring happiness to the people

- Bio-robot Field
- AI-robotics Field

Faculty

Control Theory Group Intelligent Robot Field



Mitsuji Sampei, Professor
Nonlinear Control Theory and its Application, Control of Under-Actuated Mechanical Systems, Design and Control of Multi-Rotor Systems.



Masaki Yamakita, Associate Professor
Theoretical studies on adaptive and learning control and state estimation and model predictive control for nonlinear systems, and their applications to robotic and industrial systems



Riku Funada, Assistant Professor
Cooperative Control and Strategic Sensing for Networked Robotics, Path and Sensing Planning for Robots

Control Theory Group Cyber Physical Systems Field



Yoshihiro Miyake, Professor (Dept. Computer Science)
From Communication Science to Interface Creation



Takeshi Hatanaka, Associate Professor
Cyber-Physical-Human Systems / Coordinated Control of Robotic Networks / Distributed Control and Decision for Smart Sky, Ocean, and Agriculture

Control Theory Group Complex Network Systems Field



Jun-ichi Imura, Professor
Development of control theory of large-scale complex network systems, and applications to smart grids, intelligent transportation systems, and biological systems



Tomohisa Hayakawa, Associate Professor
Control Theory, Nonlinear Dynamical Systems Theory, Digital Society Mechanism Design, Smart Cities, and Game Theory



Hideaki Ishii, Professor (Dept. Computer Science)
Large-scale networked control, Coordinated control of multi-agent systems, Distributed algorithms for PageRank computation, Cyber security for power systems



Hampei Sasahara, Assistant Professor
Cybersecurity and privacy in control systems/Mathematical analysis and system design via non-cooperative game theory/Control of large-scale complex systems/Application to smart grids



Jonatan Pena Ramirez, Specially Appointed Associate Professor
Nonlinear dynamics / Nonlinear phenomena / Synchronization and control of complex systems



Xun Shen, Visiting Assistant Professor
Development of data-driven control theory for uncertain complex systems based on probabilistic constrained optimization and statistical learning, and its application to biological network systems and intelligent driving systems.



Takashi Nakakuki, Visiting Professor
Model-based analysis and design of biomolecular reaction system / Molecular robotics / Molecular cybernetics



Shun-ichi Azuma, Visiting Professor
Control theory of network systems, Data-driven control, Swarm intelligence, Systems biology, and Sparse estimation



Kenji Kashima, Visiting Associate Professor
Control theory for large scale systems and stochastic systems /Statistical learning



Masaki Inoue, Visiting Associate Professor
Human-in-the-loop control systems, Energy management systems, Traffic management systems

Advanced Measurement Group Mechanical Design and Functional Evaluation Field



Atsushi Hirata, Professor (Dept. Mechanical Engineering)
Ultraprecision polishing, coating, laser processing, tribology and material characterization with micro/nano materials for surface function design



Seiichiro Hara, Associate Professor
Sensing method of surface texture and machining information, Processing and evaluation of measurement information, Design applying quality and sensitivity engineering, Modeling of surface texture

Advanced Measurement Group Computer Vision and Image Processing Field



Masatoshi Okutomi, Specially Appointed Professor
Computer vision and image processing, covering both their theory and applications. Recent topics include 3D scene reconstruction, stereo vision, structure from motion, inverse rendering, multispectral imaging, computational imaging, and super resolution.



Masayuki Tanaka, Professor
Image Analysis, Multispectral Imaging, Multi-Modal Image Fusion, Image Processing Based on Generative Model, Optimization and Machine Learning.



Rei Kawakami, Associate Professor
Physics-based vision, anomaly detection, video-based recognition, multimodal recognition, AR/VR



Yusuke Monno, Assistant Professor
Computer Vision, Image Sensing, Image Processing, Computational Imaging, Color and Multispectral Imaging, 3D Scene Reconstruction, Biomedical Image Processing

Advanced Measurement Group Applied Measurement Using Acoustic and Radio Waves Field



Shinji Ohyama, Associate Professor
Measurement technology such as new localization system for sensor networks, CT system for visualization of temperature and wind speed distribution

System Analysis Group Systems and Society Field



Hiroya Nakao, Professor
Nonlinear dynamics, Stochastic processes, Rhythmic phenomena, Self-organization phenomena



Misako Takayasu, Professor (Dept. Mathematical and Computing Science)
Analysis and modeling of socio-economic phenomena, big-data analysis, nonlinear transport, group motion, complex network, phase transition



Toru Aonishi, Associate Professor (Dept. Computer Science)
Computational neuroscience, Mathematical theory of neural networks, Data-driven science

Interdisciplinary
Research Groups

Mechanical Engineering

Systems and Control
Engineering

Electrical and Electronic
Engineering

Information and
Communications Engineering

Industrial Engineering and
Economics



Takayuki Ishizaki, Associate Professor

Decentralized design of large-scale distributed control systems, Electricity market design under high penetration of storage and renewable energy resources



Takahiro Tsuchida, Assistant Professor

Investigation of random phenomena in various fields, Response analysis of non-Gaussian randomly excited systems, Dynamics of fractional-order systems

System Analysis Group

Computational Mechanics Field



Kenji Amaya, Professor

Implementation of inverse analysis for industry, Electrical chemistry simulation such as Localized corrosion analysis, Electroplating analysis, Corrosion monitoring using data assimilation, Aberration analysis



Yusuke Miyazaki, Associate Professor

Development of Detailed Digital Human Models, Injury Mechanism and Prevention, Quantitative Injury Risk Assessment of Products and Living Environment, Measurement of Human Motions and Forces in Real World Environment, Sports Engineering



Isao Ono, Associate Professor (Dept. Computer Science)

Development of evolutionary computation algorithms for various optimization problems and reinforcement learning algorithms for various tasks



Yuki Onishi, Assistant Professor

Large deformation analysis using state-of-the-art FEM, Peeling analysis of plastic film, Electrodeposition of automobile body, Localized corrosion in saltwater

System Analysis Group

Power Systems for Transportation Field



Hidenori Kosaka, Professor

High Efficiency Mobility Systems, High Efficiency Clean Internal Combustion Engines, Investigation of Combustion via Laser Diagnostics, Combustion Control



Susumu Sato, Associate Professor

Improvement of Environment Load in Transportation System, High Efficiency After-treatment System, Alternative Fuel Engines



Tsuyoshi Nagasawa, Assistant Professor

Thermal and fluid engineering/Analysis and development of energy conversion and environmental load reduction technologies/Internal combustion engine/Exhaust after-treatment/Solid oxide fuel cell/Combustion synthesis of nanomaterials

System Integration Group

Bio-robot Field



Daisuke Kurabayashi, Professor

Analysis of Adaptive Behavior by using Bio-machine Hybrid Systems, Integration of Distributed Autonomous Robotic Systems, Motion and Path Planning for Robotic Systems



Motomu Nakashima, Professor

Modeling of human motion in sports, Optimization of human motion as well as design and development of optimal tools and equipment using simulation and humanoid robot



Hideyuki Tsukagoshi, Professor

Study on fluid powered actuator referring to the muscular structure and the working principle of creatures, and their application to medical robot and rescue.

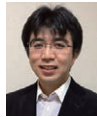

Masahiro Takinoue, Professor (Dept. Computer Science)

Construction and understanding of self-assembled artificial cell-like systems and molecular robots based on DNA nanotechnology and microfluidic technology



Akisue Kuramoto, Assistant Professor

Biomechanical analysis of worker posture/Anomaly detection in work movement/Optimal work environment design/Biological measurement/Surrounding environment recognition technology for transportation systems

System Integration Group

AI-robotics Field



Kazuhiro Nakadai, Professor

Key research topics are robot audition and computational scene analysis, and wide areas are covered such as robotics, signal and speech processing, AI, and machine learning.



Minoru Nakayama, Professor (Dept. Information and Communications Engineering)

Human visual perception is analyzed using behavioral metrics such as EEG, eye movement, pupil responses and other responses



Masayuki Yamamura, Professor (Dept. Computer Science)

Artificial Intelligence with personality and emotion, Evolvable Digital Artificial Life, Wet Artificial Life enhanced by Synthetic Biology, Molecular Robots



Katsutoshi Itoyama,

Specially Appointed Associate Professor

My research interests are focused on statistical audio signal processing and machine learning techniques for music information processing, audio-based scene analysis, and robotics.



Kenji Nishida, Specially Appointed Associate Professor

Statistical pattern recognition, Image processing, Computer vision, Machine learning, Facial expression detection for nursing and rehabilitation



Department of Electrical and Electronic Engineering



Acquisition of new scientific knowledge and pioneering new electrical and electronic engineering technologies. Contribution to society by nurturing human resources who can achieve these objectives.

Electrical and electronic engineering contributes to society in a wide range of fields. Many faculty members belong to our department, which covers a wide range of fields. The specialized fields are becoming increasingly fragmented today, but they are also compounded and closely related to each other. And sometimes, unexpected fusions with other fields arise. Therefore, future engineers and scientists need a broad perspective and deep insight, and we aim to produce human resources who can respond to these needs. We also play a role as a world-class research center where knowledge is explored and new technologies are pioneered on a daily basis.



Kotaro Kajikawa
Department Chair

Research

The field of electrical and electronic engineering includes the study of hardware and software technologies that sustain electrical power, information processing and communications technology systems, and the physical properties, devices, and other elemental technologies that keep such systems working properly. The Department of Electrical and Electronic Engineering provides an education that serves as the core of the field of study, and conducts cutting-edge academic and practical research, the results of which are presented at top-level conferences and in leading journals around the world. This allows us to contribute to both academia, and through collaborations with industry and government bodies, to the resolution of issues faced by our society.

Our primary fields of research are as follows: power electronics, electric power systems, power mechatronics, plasma engineering, light wave communications, photonic devices, wireless communication engineering, electronic devices, magnetic devices, spintronics, semiconductor processes, semiconductor devices, sensor devices, solar cells, organic electronic materials/properties, organic electronics, nonlinear optics, analog-digital hybrid integrated circuits, electronic circuits, nanoelectronics, nanophotonics, applied properties, and more.

Education

At the Department of Electrical and Electronic Engineering, students acquire the fundamental knowledge and abilities required in this diverse field that studies large-scale electric energy production and control, information transmission systems that harness optical and radio wave phenomena, information processing and communication, the circuits and signal processing that serve as the foundation of computers, integrated circuits, and electronic devices. Classes teach students the fundamental theories the field is based upon, and provide a more practical understanding through a curriculum that offers simulation exercises, the opportunity to construct integrated circuits, and micro-processing experience. Our goal is to cultivate individuals who will become pioneering researchers, leading engineers and educators with open minds, creativity, and originality - individuals capable of succeeding in the related industries and fields of research and education.

Undergraduate programs

- * School of Engineering
- * Department of Electrical and Electronic Engineering

Graduate programs

- * Electrical and Electronic Engineering
- * Energy Science and Engineering
- * Human Centered Science and Biomedical Engineering
- * Nuclear Engineering

Research Groups and Fields of Research

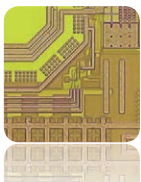

Circuit Group

Studying the most sophisticated analog and digital circuit design technologies necessary for advanced electronic devices

Integrated Circuit Field



Electric Power and Energy Group

Gaining a thorough understanding of advanced power systems, power conversion, electrical equipment, high voltage and environmental technologies

Electric power system Field
Power electronics Field
Plasma and environment Field
Electric machinery Field



Photonics, Ultrasonics, and Communications Group

Researching the hardware and software needed to build the next generation of communications networks

Photonics Field Informatics Field
Wireless communications Field Ultrasonics Field



Electronic Materials Group

Developing cutting-edge devices and methods to control the physical properties of new functional materials

Informatics Field
Energy Electronics Field
Spintronics Field
Nano- and Bio-photonics Field
Organic electronics Field
Integrated electronics Field
Bioelectronics Field



Device Group

Researching the innovative devices needed to create advanced low power and ultra-fast electronics

Green Device Field
Compound Semiconductor Device Field
Terahertz device Field
Quantum Functional Device Field
Intelligent Device Field

Faculty

LANE: Laboratory for Advanced Nuclear Energy
FIRST: Laboratory for Future Interdisciplinary Research of Science and Technology

Circuit Group

Integrated Circuit Field



Kenichi Okada, Professor

Millimeter-wave Wireless Transceiver / 5G / Battery-less IoT Wireless Sensor Node / CMOS Integrated Circuits / PLL / Atomic Clock / Terahertz Communication & Sensing & Imaging



Atsushi Shirane, Associate Professor (FIRST)

5G, IoT, Satellite Communication, Wireless Communication, Wireless Power Transfer, Machine Learning



Takashi Tokuda, Professor (FIRST)

Integrated Circuits, Sensors, Optoelectronics, Biomedical Devices, IoT Devices, Wireless Circuits



Yasufumi Yokoshiki, Assistant Professor (FIRST)

Integrated Circuits, Odor sensor, Gas sensor, Biological sensor, IoT device, Energy harvesting



Hiroyuki Ito, Associate Professor (Nano Sensing Unit)

Integrated Circuit Technology / Sensing System with Ultra High Sensitivity / Intelligence of Things / Edge AI / IT for Agriculture



Sangyeop Lee, Assistant Professor (FIRST)

MEMS acceleration sensor/microwave, millimeter-wave (mmW), sub-terahertz (sub-THz) circuits/Beyond 5G (B5G) communication system

Photonics, Ultrasonics, and Communications Group

Wireless Communications Field



Jiro Hirokawa, Professor

Millimeter-wave high-efficiency planar antenna, 2D beam-switching circuit, fast analysis for antenna design, 2D orthogonal multiplexing



Takashi Tomura, Tenure-track Assistant Professor

Research based on electromagnetic engineering: small-satellite onboard antennas, Origami deployable membrane antennas, millimeter- & THz-wave-band antennas & material characterization



Kei Sakaguchi, Professor

Wireless communication engineering
B5G / IoT / Millimeter-wave / Wireless energy transmission
Connected car / Automated driving



Tran Gia Khanh, Associate Professor

Gbps-class wireless backbone network, Radio resource management using AI, IoT networks employing drones



Takahiro Aoyagi, Associate Professor

Electro Magnetic Comatibility (EMC), Measurement of Electrical Properties, Wave Propagation, Wireless Communication System, Body Area Networks



Atsuhiko Nishikata, Associate Professor

EMC / RF material evaluation / EM shielding and absorption
MMW's biological thermal effect / Radio retroreflector
EM source estimation / Spatial acoustics



Teruya Fujii, Specially Appointed Professor

Wireless transmission technologies for the 6th mobile communication system / The 3D cell layout and network cooperation control / HAPS Cellular system / Cellular drone repeater system for disaster



Hideki Omote, Specially Appointed Associate Professor

6th mobile communication system / Radio propagation for the 6th mobile communication system and HAPS cellular system / International standardization of mobile radio propagation

Photonics, Ultrasonics, and Communications Group

Photonics Field



Nobuhiko Nishiyama, Professor

Photonic-electronic convergence integrated circuits based on heterogeneous integration / High-speed semiconductor lasers / Lidar system for car



Shigeru Nakagawa, Professor (FIRST)

Vertical Microcavity Single Photon Source / Integrated Photonics / Photonic Quantum Computer / Photonic Reservoir Computing



Yuya Shoji, Associate Professor (FIRST)

Waveguide optical isolator / Magneto-optical signal processing device / Silicon photonics / Photonic integrated circuit / On-chip photonic network device



Kensuke Ogawa, Specially Appointed Professor

Photonic integrated circuits / Optical devices on photonic-electronic integration platforms / Ultrafast photonics / Time-resolved spectroscopy / Lightwave sensing / Optical interferometry



Tsuyoshi Horikawa, Specially Appointed Professor

Si-photonics devices / Integrated Photonics Platform / Wafer-level Photonic Device Test System / Photonic Device Statistical Analysis



Yoshitaka Oiso, Specially Appointed Associate Professor

Semiconductor Photonic Devices / Crystal Engineering / Semiconductor Process



Fumio Koyama, Specially Appointed Professor (FIRST)

VCSEL photonics, photonic integrated devices, high-speed semiconductor lasers, optical communications and interconnects, optical sensing for automotive applications, high power semiconductor lasers



Hiroyuki Uenohara, Professor (FIRST)

Photonic network, switching technologies for large capacity, low latency edge/cloud computing / Optical MUX/DEMUX techniques and related photonic integrated device with high spectral efficiency / Optical nonlinear compensation with machine learning.



Yohei Aikawa, Assistant Professor (FIRST)

Optical communication engineering / Optical signal processing for logical operations / Optical integrated devices / Photonic accelerator with Silicon photonics



Tomoyuki Miyamoto, Associate Professor (FIRST)

Configuration of optical wireless power transmission (OWPT) systems / Development of modules and devices for OWPT / Creation of new applications of OWPT

Photonics, Ultrasonics, and Communications Group

Informatics Field



Tomohiro Amemiya, Associate Professor

Optical informatics / Next-generation optical semiconductor technology / Integrated photonics / Photonic nanostructures

Photonics, Ultrasonics, and Communications Group

Ultrasonics Field



Kentaro Nakamura, Professor (FIRST)

Ultrasonic transducers and industrial applications of ultrasonics; Medical applications of optical/ultrasonic methods; Optical fiber sensors and their applications



Marie Tabaru, Associate Professor (FIRST)

Biomedical Engineering Measurement / Agricultural Engineering Measurement / Medical Engineering / Wave Engineering / Advanced Diagnostic Imaging

Interdisciplinary Research Groups

Mechanical Engineering

Systems and Control Engineering

Electrical and Electronic Engineering

Information and Communications Engineering

Industrial Engineering and Economics



Yuji Wada, Assistant Professor (FIRST)
 Ultrasonic engineering/ Acoustic streaming/ Ultrasonic levitation of droplet/ Numerical analysis/ Multiphase topology optimization



Minoru Kuribayashi Kurosawa, Associate Professor
 Acoustics/Ultrasonics/Mechatronics/Transducers Surface acoustic wave motor/Piezoelectric device Energy harvesting/ Hi-Fi audio/Passive intermodulation

Device Group
Compound Semiconductor Device Field



Yasuyuki Miyamoto, Professor
 Compound Semiconductor electron devices /Steep Slope FET /InP /GaN /Crystal growth/Ultrafine process



Masahiro Watanabe, Associate Professor
 Nanostructure devices, Function design of electronic and photonic devices: Nanostructure-silicon photonics, Nonvolatile quantum effect memory, Advanced nano-heterostructure process technology



Hitoshi Wakabayashi, Professor
 Electron Devices: Advanced 3D MISFET (Silicon) and 2D FET



Iriya Muneta, Assistant Professor
 Spintronics/Transition-metal chalcogenides/2D layered materials/Magnetism/Valleytronics/Electron correlation/Magneto-resistance/Spin injection



Takuya Hoshii, Assistant Professor
 Semiconductor devices/process technology/MISFET and MIS-HEMT/power devices/atomic level analyses of doped impurities/crystal growth

Device Group
Quantum Functional Device Field



Takamasa Kawanago, Assistant Professor (FIRST)
 Self-assembled molecule monolayer for gate dielectrics
 Transfer printing for building functional devices
 Organic/inorganic interfacial phenomena

Device Group
Intelligent Device Field



Shun-ichiro Ohmi, Professor
 Semiconductor devices, Integrated electron device. Research on new functional device utilizing high-k and ferroelectric thin films

Device Group
Terahertz Device Field



Safumi Suzuki, Associate Professor
 Terahertz Devices, Resonant Tunneling Diodes, Active Metamaterials, THz Wireless Communication, THz Radar System, THz 3D Imaging

Device Group
Green Device Field



Mutsuko Hatano, Professor
 Quantum sensors and power devices using widegap semiconductors. Developing wide-field technologies from materials to systems for energy and medical applications.



Tetsuo Kodera, Associate Professor
 Fundamental technologies toward quantum communication and quantum computers, Group IV semiconductor physics, Quantum spin physics, New functional devices using quantum technologies.



Takayuki Iwasaki, Associate Professor
 Quantum sensing and quantum emitter using atomic-scale structures in diamond toward next-generation low-loss power devices and biological/medical applications.



Kuniyuki Kakushima, Associate Professor
 Interface control based on process and material development for semiconductor devices including memory, energy, power (Si, wide bandgap), medical imaging.

Electronic Materials Group
Informatics Field



Keigo Arai, Associate Professor
 Precision sensing and imaging via quantum manipulation of spins in diamond/From development of new measurement protocols to applications in life science and electronics for the IoT era

Electronic Materials Group
Energy Electronics Field



Akira Yamada, Professor
 Photovoltaic materials (Cu(In,Ga)(SSe)₂) / Transparent conductive oxides (ZnO, Zn(O,S) / Semiconductor Physics / Device simulation



Shinsuke Miyajima, Associate Professor
 Semiconductor/Photoelectric conversion materials and devices/Group IV amorphous and nanocrystalline, Oxide, and Organic-inorganic perovskite materials



Takahito Nishimura, Assistant Professor
 Photoelectric conversion materials and devices / Flexible devices / Multinary inorganic compounds / Transparent conductive oxides / Chalcogenide thermoelectric materials

Electronic Materials Group
Spintronics Field



Shigeki Nakagawa, Professor
 Spintronics (Perpendicular MRAM, Half-metallic ferromagnets), Magnetic films for energy conversion, Magnetic film devices with high magnetic anisotropy, High density magnetic recording technology



Yota Takamura, Assistant Professor
 Spintronics (Half-metallic ferromagnets, Si-based devices, Perpendicular magnetic anisotropy, Superconductors) Soft magnetic thin films for power electronics applications



Pham Nam Hai, Associate Professor
 Spintronics/Ferromagnetic semiconductor/Topological Insulator/Magnetoresistive Random Access Memory/Magnetic sensor/Semiconductor spin device

Electronic Materials Group
Nano- and Bio-photonics Field



Kotaro Kajikawa, Professor
 Our group aims at developing the fields of nanophotonics, surface plasmon, and meta and the related for novel optical devices.



Mana Toma, Associate Professor
 Plasmonics/Nano-Micro Structure Science/Biosensor



Haruhiko Ito, Associate Professor

We study Nanophotonics with near-field light and Atom-photonics for controlling laser-cooled atoms, and develop quantum-functional devices with atoms and spins.

Electronic Materials Group

Organic Electronics Field



Takaaki Manaka, Professor

Organic electronics/Organic devices/Evaluation techniques for organic semiconductor/Organic dielectric materials/Non-linear Optics/Liquid Crystals



Dai Taguchi, Associate Professor

Analysis of electrical and electronic materials, and novel electrical and optical techniques for probing these materials based on dielectric physics.



Hiroaki Iino, Associate Professor (FIRST)

Organic electronics/Imaging devices/Liquid crystalline organic semiconductors/Organic thin film transistors/Printed electronics/Molecular alignment

Electronic Materials Group

Integrated Electronics Field



Satoshi Sugahara, Associate Professor (FIRST)

Integrated Devices and Circuits/High-Speed and Low-Power Devices/Energy-Efficient Circuits/Wearable Electronics

Electronic Materials Group

Bioelectronics Field



Takamichi Nakamoto, Professor
(Dept. Information and Communications Engineering)

Biologically-inspired Sensors/Electronic Measurement/Embedded Systems/Human Olfactory Interface/Odor Sensor/Olfactory Display

Electric Power and Energy Group

Electric Power System Field



Kenichi Kawabe, Tenure-track Assistant Professor

Power system engineering/Power engineering/Wind power/Photovoltaic power/Energy storage/Power electronics-based devices/Mathematical Programming

Electric Power and Energy Group

Power Electronics Field



Hideaki Fujita, Professor

Power electronics circuits and systems for solar, wind, micro-hydro power generation. High-efficiency and multifunctional power converters for industrial motor drive and induction heating.



Makoto Hagiwara, Associate Professor

Application of power electronics to next-generation electric power systems, battery energy storage systems, electric vehicles and renewable energies.



Kenichiro Sano, Tenure-track Assistant Professor

Power Electronics in electric power systems: High voltage DC transmission for offshore wind farms, transient analysis of power systems, power qualities in distribution systems



Takahiro Urakabe, Specially Appointed Professor

Power electronics, Modeling of power semiconductor devices



Shigeki Harada, Specially Appointed Associate Professor

Power electronics, Modeling of power semiconductor devices

Electric Power and Energy Group

Electric Machinery Field



Akira Chiba, Professor

Power Mechatronics and Intelligent Drive: Bearingless motor drive with integrated motor and magnetic bearing functions. Switched reluctance motors for high efficiency and compactness for EV, hybride vehicles, and next generation automobiles.



Kyohei Kiyota, Associate Professor

Electric machinery/Mechatronics/Rare-earth Free Motors/Reluctance motors/Motors for vehicles/Bearingless motors/Magnetic bearings



Yusuke Fujii, Assistant Professor

Electric machinery/power electronics/control theory/magnetic suspension/motor drive



Hiroshi Nakamura, Specially Appointed Professor

Lightweight actuators for future collaborative robots/ Mechatronics/Motion control

Electric Power and Energy Group

Plasma and Environment Field



Nozomi Takeuchi, Associate Professor

Plasma Engineering/High Voltage Engineering/Electrostatic Engineering/Plasma in contact with liquid for advanced water treatment process and treatments of carbon materials/Electrohydrodynamics and its applications



Shungo Zen, Assistant Professor

Atmospheric pressure plasma application/Plasma Engineering/High Voltage Engineering/Power Engineering/Energy Storage Material/Solar Cell/Hybrid DCCB



Hiroshi Akatsuka, Associate Professor (ZC)

Modeling of atomic-molecular processes in plasmas, spectroscopic measurement/Interaction with electromagnetic field/Fundamentals of plasma electronics



Akitoshi Okino, Associate Professor (FIRST)

Development of brand-new atmospheric plasma sources and its applications for medical/analytical/material field

Department of Information and Communications Engineering

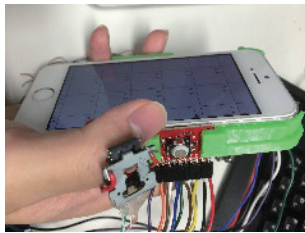
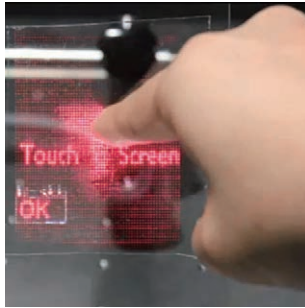

Contributing to a richer, more sustainable society through research and education aimed at advanced information and communication technologies

One of the defining characteristics of our department is the interdisciplinary academic environment designed to aid in the development of information and communications technologies (ICT) designed for human use. The research and education cover a broad range of topics, from the hardware that is the foundation of information processing, to signal processing technologies, machine learning technologies, advanced intelligent information processing, the mechanisms behind human recognition, human interface systems, and medical technology. We are also actively engaged in collaborative research with corporations and research institutions in Japan and around the world, and provide students with numerous opportunities to experience that work first-hand. Information and communications technologies will continue to evolve, and the roles they play in society will likely increase as well. We educate students with hopes and dreams and untamable vitality, who will lead the drive towards a rich and exciting future with ICT.



Hirohiko Kaneko
Department Chair

Research

The aim of the Department of Information and Communications Engineering is to contribute to the academic fields that study both fundamental and applicable hardware and software technologies that will allow us to build a sustainable and user-friendly ICT-based society. In order to construct human-centric ICT systems, we need a better understanding of human emotion and the cerebral mechanisms upon which those emotions are based. In addition, we must build structures that allow for effective communication between people and the machines they use, and mechanisms for advanced information processing beyond human capabilities. In order to realize these objectives, we require technologies that can process and transmit vast amounts of information quickly. It is for this reason that the Department of Information and Communications Engineering conducts research in a broad range of technical fields, and puts a strong focus on the intercommunication and exchange between those fields. In concrete terms, our research efforts are directed towards ICT study, in areas that include communications and networks, signal processing, very-large-scale integration (VLSI), computers, security, media information processing, biometric information processing, sense information processing, and intelligent information processing. ICT systems have the potential to change our lives greatly, and our goal is to continuously work towards expanding that potential from the very frontier of the fields.

Education

Students in the master's program gain a fundamental understanding and practical skills as we foster within them a broad overview of the ICT industry as a whole. They simultaneously engage in a variety of activities that provide them with a strong ethical stance needed when viewing the world from the global perspective and engaging in research and development. The aim of these efforts is to graduate future researchers and engineers with a level of competence that is world-class, resulting in leading individuals capable of working in industries around the globe. In the doctoral program, the aim is the help students develop these abilities and perspectives even further, and to cultivate further leaders who will carve a path to new frontiers of science and technology that will make our global society even richer.

Many students who graduate from this department and the specialty program that was its predecessor move on to work in jobs connected to electronic and electrical engineering and in corporations active in the field of ICT. Our graduates are active in a broad range of other fields as well, with some moving on to positions in the mechanical and automobile industries or in chemical/material related work, and some working in the fields of finance and consulting. Graduates of our doctoral degree program can also be found at universities and private research institutes both here in Japan and abroad.

Research Groups and Fields of Research

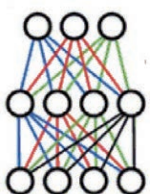

Human Information Systems Group

Clarifying the underlying mechanisms of human senses, perception, cognition, and motor control, engineering mechanisms that mimic those functions, and researching their application systems

- Sensory Information Processing Field
- Intelligent Information Processing Field
- Media Information Processing Field
- Biological Information Processing Field

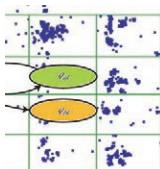

Signal Processing Group

Researching fundamental mathematical technologies and effective algorithms for processing various types of signals

- Media Signal Processing Field
- Inverse Problems Field

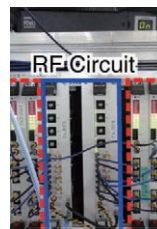

Communication, Networks, and Security Group

Researching algorithms and hardware systems that ensure safe, accurate, and speedy transmission of information

- Communication Systems Field
- Information Theory and Security Field
- Communication Networks Field

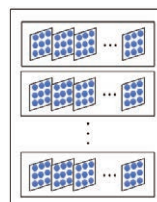

Integrated Circuit and Computer Group

Researching the algorithms, design technologies, and mechanical systems required to produce high-performance computational systems

- Digital Integrated Circuits Field
- Analog Integrated Circuits Field
- Distributed Information and Advanced Communication Systems Field

Faculty

Human Information Systems Group

Sensory Information Processing Field



Hirohiko Kaneko, Professor

Visual information processing, Psychophysics, Space perception, Stereopsis, Binocular disparity processing, Multisensory integration, Eye movements, Perceptual adaptation



Yasuharu Koike, Professor (Biointerfaces Unit)

Computational Neuroscience, Human Motor Control Theory, Human interface: Brain Machine Interface, Analysis of subjective feeling based on computational model



Natsue Yoshimura, Professor (Dept. Computer Science)

Brain activity information decoding (motor control, emotion, language, etc)/Brain-machine interfaces/Machine learning/EEG/fMRI



Imari Sato, Visiting Professor

Computer vision, Computer graphics, Spectral imaging, Computational photography, and Modeling reality.



Takehiro Nagai, Associate Professor

Psychophysics/affective engineering/color engineering/color perception/material perception/image processing based on properties of human visual perception



Rumi Hisakata, Assistant Professor

Psychophysics/Human visual processing/Binocular vision and 3D perception/Motion perception/Visual illusions/small eye movements/visual stability



Supat Saetia, Assistant Professor (Biointerfaces Unit)

Computational Neuroscience, Brain Connectivity Modeling, Causal Discovery Algorithm, Episodic Memory, Brain-Machine Interface

Human Information Systems Group

Intelligent Information Processing Field



Itsuo Kumazawa, Professor (FIRST)

Image Processing, Image Recognition, User Interface, Tactile Display, Optical Sensor, Virtual Reality, Artificial Neural Network



Nobuhiko Sugino, Professor (GSIC)

Code Optimization Methods for GPGPU, Automatic Parallelizing Compilers, Implementation Techniques of Digital Signal Processing



Masato Motomura, Professor (AI Computing Research Unit)

Reconfigurable Hardware, Intelligent Computing, Deep Learning Processor, Annealing Machine



Minoru Kuribayashi Kurosawa, Associate Professor (Department of Electrical and Electronic Engineering)

Acoustics/Ultrasonics/Mechatronics/Transducers Surface acoustic wave motor/Piezoelectric device Energy harvesting/Hi-Fi audio/Passive intermodulation



Momoko Nakatani, Associate Professor

Human computer Interaction, Service Design, User Experience, Communication Enhancement, Well-being



Yoshihiro Watanabe, Associate Professor

Computer vision, Augmented reality, Visual display, Digital archiving, Human computer interaction



Thiem Van Chu, Assistant Professor (AI Computing Research Unit)

Computer Architecture, Reconfigurable Hardware, FPGA, AI Computing

FIRST: Laboratory for Future Interdisciplinary Research of Science and Technology
GSIC: Global Scientific Information and Computing Center
ASIST: Advanced Research Center for Social Information Science and Technology
WRHI: Tokyo Tech World Research Hub Initiative

Human Information Systems Group

Media Information Processing Field



Manabu Okumura, Professor (FIRST)

Natural language processing, text summarization, computer assisted language learning, sentiment analysis, text data mining



Konstantinos Slavakis, Professor

Signal Processing, Machine Learning, Data Analytics



Takamichi Nakamoto, Professor (FIRST)

Human Olfactory Interface/Olfactory Display/Odor Sensing System/Sensory Information Processing/Embedded System/Biomimetic Sensing System



Masahiro Yamaguchi, Professor

Optical imaging and display/Spectral imaging/Color reproduction/Image analysis for pathology/Holography/Light-field display/3D user interface

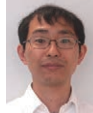

Takahiro Shinozaki, Associate Professor

Speech recognition and understanding, Speech and Language Processing, Machine learning



Shoichi Hasegawa, Associate Professor (FIRST)

Virtual reality / Haptics / Physics engine / Metaverse / Character Motion



Kotaro Funakoshi, Associate Professor (FIRST)

Natural language processing, Multimodal dialogue system, Human-machine interaction



Dani Prasetyawan, Assistant Professor

Odorant analysis / Odor reproduction analysis / multi array gas sensors / multivariate analysis



Saori Takeyama, Assistant Professor

Remote sensing data processing, Signal processing, Image processing, Mathematical optimization

Human Information Systems Group

Biological Information Processing Field



Kenji Suzuki, Professor (Biomedical AI Unit)

We develop computational intelligence that learns, from image examples, physicians' knowledge in interpreting images to help make smart decisions in biomedicine.



Kentaro Nakamura, Professor (FIRST)

Ultrasonics, High power ultrasonics, Optical instrumentation, Optical fiber sensors, Medical measurement and imaging with ultrasonic and optical methods



Takashi Obi, Associate Professor (FIRST)

Medical information system, Medical information network, National e-ID, Medical image processing, Medical information analysis



Marie Tabaru, Associate Professor (FIRST)

Biomedical Engineering Measurement/Agricultural Engineering Measurement/Medical Engineering/Wave Engineering/Advanced Diagnostic Imaging



Ze Jin, Assistant Professor (Biomedical AI Unit)

Medical image processing and image analysis, machine learning and deep learning in the medical field, development of computer-aided diagnosis systems for medical images

Signal Processing Group

Media Signal Processing Field



Minoru Nakayama, Professor

Human visual perception and their characteristics in various aspects are analyzed using some behavioral metrics such as EEG, eye movement, pupil responses and other responses.



Izumi Ito, Assistant Professor

Signal processing/Image processing/Transforms and spectral techniques

Signal Processing Group

Inverse Problems Field



Isao Yamada, Professor

Mathematical models and algorithms for signal processing, optimization, inverse problems and machine learning

Communication, Networks, and Security Group

Communication Systems Field



Kazuhiko Fukawa, Professor

Transmission and network techniques for wireless communications by developing digital signal processing, adaptive filters, and statistical based algorithms.



Satoshi Suyama, Visiting Professor

Next generation mobile communication system/Radio access technologies/Radio Access Networks/Mobile Radio Applications



Yuyuan Chang, Assistant Professor

Mobile communication, millimeter wave communication, multiple input multiple output (MIMO) systems, multi-user MIMO (MU-MIMO) systems, user scheduling, wireless sensor network

Communication, Networks, and Security Group

Information Theory and Security Field



Tomohiko Uyematsu, Professor

Information theory for non-parametric data, network information theory, and random number generation



Wakaha Ogata, Professor

Cryptography, Encryption, Digital signature, User authentication, Secret sharing, Cryptographic protocol, Multi-party protocol



Ryutaroh Matsumoto, Professor

Quantum Information Processing, Information Theoretic Security, Algebraic Error-Correcting Code, Adversarial Machine Learning



Kenta Kasai, Associate Professor

Coding Theory/LDPC Codes/Spatially-Coupled Codes/Graphical Models/Fountain Codes/Quantum Error Correcting Codes/Memory Channels



Yutaka Jitsumatsu, Associate Professor

Wireless Communication, Multiple Access Method, Physical Layer Security, MRI reconstruction using deep learning



Fukang Liu, Assistant Professor

Cryptography / Symmetric-key cryptography / Hashfunction / Authenticated encryption / Cryptanalysis design

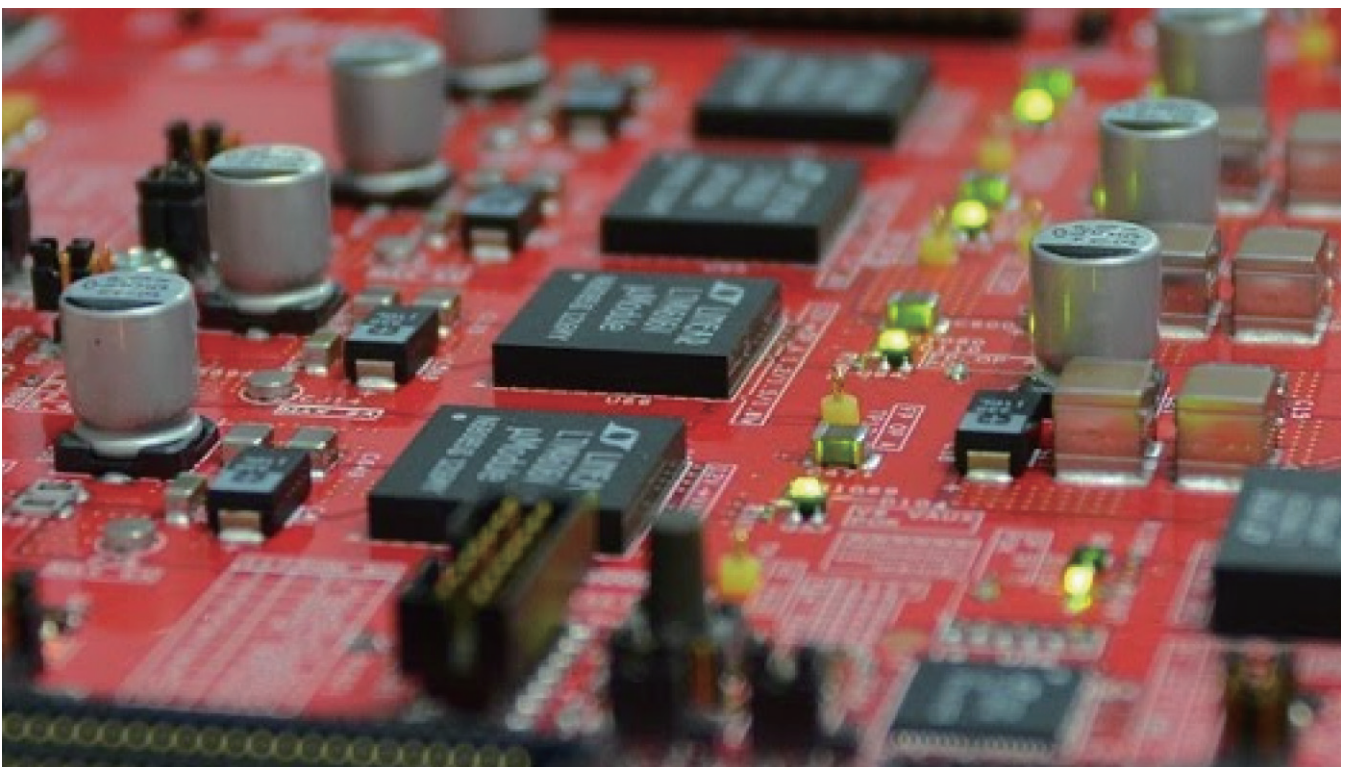

Integrated Circuit and Computer Group
Digital Integrated Circuits Field



Tsuyoshi Isshiki, Professor
 System-on-Chip design verification automation, high-performance processor design automation, secure VLSI architecture



Atsushi Takahashi, Professor
 High-performance VLSI Design System/Electronic Design Automation (EDA)/Physical Design/Design for Manufacturability (DFM)/Next-Generation Lithography/Graph Theory/Combinational Optimization/Synchronous Circuits/Adaptive Computation



Yuko Hara, Associate Professor
 Embedded Systems, Internet-of-Things (IoT), High-Level Synthesis, Logic Synthesis, Hardware/Software Co-design, Computer Aided Design (CAD), Architecture/Microprocessor, FPGA



Satoshi Tayu, Assistant Professor
 Graph algorithm/Combinatorial optimization



Dongju Li, Assistant Professor
 Fingerprint Authentication/SOC Architecture/Information Security

Integrated Circuit and Computer Group
Analog Integrated Circuits Field



Shigetaka Takagi, Professor
 Our main research topics are analog integrated circuit designs for high linearity, high-speed operation, low supply voltage operation, reduction in power consumption, etc.



Hiroki Sato, Assistant Professor
 CMOS Analog Integrated Circuit, Low-Voltage Circuit Technique, Signal Processing, IP Networking, Computer Security

Integrated Information and Communications Group
Distributed Information and Advanced Communication Systems Field



Katsunori Yamaoka, Professor
 Information and Communication Network/Internet Technology/Telecommunication Networking/Next and Future Network/Network Engineering for Multimedia and Application



Hiroshi Sasaki, Associate Professor
 Computer Architecture, Computer Security, Computer Systems, Internet of Things (IoT), Workload Characterization



Hiroki Nakahara, Associate Professor
 Reconfigurable System, FPGA, Deep Learning, Multi-Valued Logic



Takayuki Nishio, Associate Professor
 Wireless Networks, MAC Protocol, Machine Learning, Computer Vision, Network Computing, IoT, Multimodal Wireless/Sensing



Akira Jinguji, Assistant Professor
 Computer Architecture, Reconfigurable System, FPGA Accelerator, Machine Learning, Deep Learning Compiler



Department of Industrial Engineering and Economics



How do we more effectively produce and offer better products at lower prices? In order to help people live richer, happier lives, we must thoroughly and logically consider scientific and technological perspectives on what sort of society we should build for the future.

It is necessary to utilize scientific tools such as modelling, quantitative analysis, and statistical processing to better respond to constantly changing financial and operational conditions. The knowledge and understanding gleaned using these tools can be used to build even better systems when we utilize the strengths of engineering approaches that have been honed through on-site experience.

This is the strength of the Department of Industrial Engineering and Economics - the ability to combine the theoretical base provided by science and engineering with practical skills and experience.



Dai Senoo
Department Chair

Research

Our aim is to analyze various issues in corporate management and economics from the perspectives of mathematics, science, engineering, business administration, economics and various other fields of study, and attempt to find solutions. It is for this reason that the areas and topics of research undertaken in this department are so diverse.

Areas of study include: business strategy; capital procurement and investment; organization management; strategic and financial analysis of management activities through marketing and other means; production management; quality management; supply chain management; finding solutions to various corporate operational issues using management information systems; industrial engineering; ergonomics; cognitive engineering; psychological understanding of human behavior; operations research; optimization; development of mathematical problem solving methods such as analysis of big data; game theory; micro/macro economics; econometrics; experimental economics; economic behavioral analysis using mathematical and engineering approaches.

Education

Our curriculum is centered on four pillars of mathematics, economics, business administration, and management technology, and it is designed to provide a focus on specific subjects while helping students reach their educational goals. Our students are able to become engineers, researchers, and specialists with rich imaginations, with the ability to come up with theoretical structures that carve out new areas of research, and with open minds that enable them to put their ideas into practical use.

Approximately 70% of our undergraduates advance to graduate study, while the others start working after their undergraduate degree in various industries that include manufacturing and consulting, and financial industries such as banking, insurance, and securities. Graduates with master's degree also go on to work in a broad range of industries, while the relatively high rate of students work in manufacturing and consulting-related fields. Graduates of the Department of Industrial Engineering and Economics have excellent mathematical abilities and are well-versed in both management and economics theory. They can be found in a broad array of fields, and they are highly thought of in all industries in which they work.

Research Groups and Fields of Research



Advanced Management and Paradigm Creation Group

Developing optimization methods through engineering analysis focused on industrial processes including development, production, and sales, and on human behavior in those processes.

Industrial System Field
Human Centered System Field
Operations Management Field



Corporate System Creation Group

Conducting scientific analysis of corporations that act as drivers of innovation, and presentation of strategies for optimal corporate governance, management/organization, marketing, and capital.

Corporate Governance System Field
Management Strategy / Marketing Field

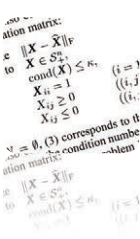

Analysis Method Creation Group

Developing analytical methods for diverse types of information and optimization methods of management and economic activities, based on mathematical and statistical analysis and active utilization of AI.

Mathematical Sciences and Informatics Field
Operations Research Field
Econometrics Field
Business Data Science Field

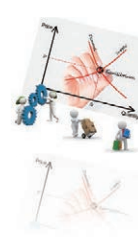

Economic Science Group

Analyzing economic and social systems based on economics, and designing and presenting policies and institutions that could achieve desirable economic and social situations.

Macroeconomics/Clometrics Field
Microeconomics/Game Theory Field
Humanomics Field
Global Environmental Research Field

Faculty

Advanced Management and Paradigm Creation Group Industrial System Field



Katie Seaborn, Associate Professor
Researching the design and evaluation of interactive agents/interfaces/experiences that use attitude and behavior change methods for personal and social good

Advanced Management and Paradigm Creation Group Human Centered System Field



Hiroyuki Umemuro, Professor
Products or services that provide affective experiences/technology and aging/human-robot(agent)-interaction/management considering affective experiences of stakeholders



Hiroataka Aoki, Associate Professor
Cognitive ergonomics/cognitive task analysis applying eye tracking technique/usability and user experience evaluation/development of cognitive task analysis methods/industrial engineering



Mayu Koike, Assistant Professor
① Human-Agent Interaction ② Anthropomorphism ③ Romantic Relationships ④ Well-being

Advanced Management and Paradigm Creation Group Operations Management Field



Xiuzhu Gu, Associate Professor
Risk management / patient safety / healthcare operations management / applied ergonomics / occupational health and safety



Ryuji Uozumi, Associate Professor
Biostatistics / Medical Statistics / Design and Analysis of Clinical Trials / Survival Analysis / Statistical Science / Causal Inference / Data Science / Clinical Research

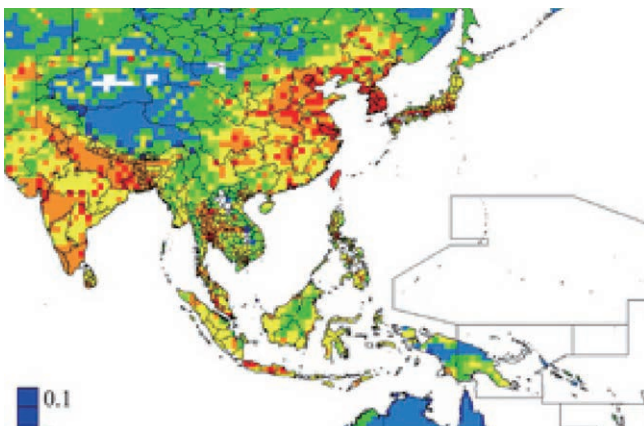

Analysis Method Creation Group Mathematical Sciences and Informatics Field



Tomomi Matsui, Professor
Optimization Algorithms based on Mathematics and Informatics./Discrete Optimization/Combinatorics/Operations Research/Algorithm



Akiyoshi Shioura, Professor
Theory of discrete convex analysis/efficient algorithms for discrete optimization problems/application to operations research, mathematical economics, etc.



Nobutaka Shimizu, Assistant Professor
average-case complexity/randomized algorithm/random walk/random graph

Analysis Method Creation Group Econometrics Field



Kota Ogasawara, Associate Professor
Cliometrics/Natural Experiments/Health Economics/Human Capital Formation/Empirical Economics/Applied Econometrics

Analysis Method Creation Group Business Data Science Field



Kazuhide Nakata, Professor
We focus on operations research, machine learning, and optimization. In particular, we develop algorithms for precisely analyzing large scale models.



Ryutaro Ichise, Professor
Artificial Intelligence/Machine Learning/Semantic Web/Data Mining/Relational Learning/Ontology/Knowledge Graph/Knowledge Discovery/Cognitive Architecture



Ken Kobayashi, Assistant Professor
Mathematical optimization/Operations research/Applications of mathematical optimization to management science and engineering

Corporate System Creation Group Corporate Governance System Field



Kotaro Inoue, Professor
Corporate finance/corporate investment policy/financial policy/corporate governance/behavioral finance



Kyoko Nagata, Associate Professor
Corporate evaluation/corporate governance/profit adjustment/empirical research on capital market



Yosuke Kimura, Assistant Professor
Corporate finance/asset pricing/firm dynamics/macroeconomics

Corporate System Creation Group
Management Strategy / Marketing Field



Chung Sulin, Associate Professor
 Marketing/Distribution strategies/Retail internationalization (especially internationalization and digitalization strategies of convenience store)

Economic Science Group
Macroeconomics/Cliometrics Field



Takeo Hori, Associate Professor
 Macroeconomics/Economic Growth/Technical Progress/Structural Transformation/Heterogeneous Agents/Sustainability of Public Debts/Monetary Policy



Hiroshi Morita, Associate Professor
 Macroeconomics, Time series analysis

Economic Science Group
Microeconomics / Game Theory Field



Takehiko Yamato, Professor
 Economic mechanism design/Market and public goods provision mechanisms: theory and experiments/Behavioral game theory and implementation theory



Ryo Kawasaki, Associate Professor
 Game theory/Mathematical economics/Application of stable sets in economics/Potential games and their applications/Analysis of markets with indivisibilities

Economic Science Group
Humanomics Field



Dai Senoo, Professor
 Theory of Organization, Strategy, Knowledge Management and Information Systems. Main projects are Creative Office, Open Innovation and Business Ecosystem.



Emiko Fukuda, Associate Professor
 Industrial economics/experimental economics/numerical analysis of game theory model/congestion management/security and disaster-relief service

Economic Science Group
Global Environmental Research Field



Toshihiko Masui, Visiting Professor
 Development of integrated assessment model toward low-carbon and sustainable society, and quantification of future scenarios by using the developed model.



Yuko Kanamori, Visiting Associate Professor
 Development and analysis of environmental model of household sector/lifestyle/population and household structure analysis



Yosuke Munesue, Assistant Professor
 Impacts of food losses and waste on global food insecurity, natural resources, and greenhouse gas emissions/food loss reduction in the Sustainable Development Goals



Selected Research and Education Projects

MEXT-Quantum Leap Flagship Program

Quantum Metrology and Sensing

Development of innovative sensor systems by highly sophisticated control of solid quantum sensors

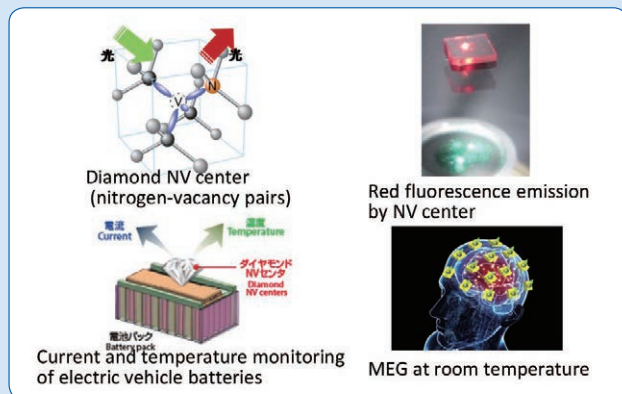

Research Overview

Overview:

In this research, four companies, two national laboratories, and five universities have established a networked research hub with Tokyo Tech as the core, and are conducting integrated research and development from the physics of solid-state quantum sensors to their applications. Developing prototypes of quantum sensors by utilizing diamond NV center (nitrogen-vacancy pair), whose spin coherence is excellent even at room temperature in the atmosphere and whose quantum states can be initialized and read out by light.

Goals of Research and Development:

- Development of prototypes for magnetoencephalography (MEG) with high sensitivity and high spatial resolution.
- Development of prototypes for systems monitoring the current and the temperature in batteries and power devices.

Members

Mutsuko Hatano, Prof. (Electrical & Electronic Eng., P.18)
Takayuki Iwasaki, Assoc. Prof. (Electrical & Electronic Eng., P.18)
Shigeki Nakagawa, Prof. (Electrical & Electronic Eng., P.18)
Kenichi Okada, Prof. (Electrical & Electronic Eng., P.17)
Yoshitaka Oiso, Specially Appointed Assoc. Prof. (Electrical & Electronic Eng., P.17)

Tadashi Sakai, Specially Appointed Prof. (School of Engineering, P.4)
Keigo Arai, Assoc. Prof. (Electrical & Electronic Eng., P.18)
Nobuhiko Nishiyama, Prof. (Electrical & Electronic Eng., P.17)
Yota Takamura, Assis. Prof. (Electrical & Electronic Eng., P.18)
Naoto Sekiguchi, Specially Appointed Assistant Professor (School of Engineering, P.4)

National Institute of Information and Communications Technology (NICT)

Research Overview

Due to the recent advancement of AI and IoT technologies, wireless traffic is increasing year by year. 1000 times increase in 20 years is estimated for the world-wide wireless traffic. Further advanced technology is required for supporting the wireless traffic.

This research project is for further improvement of 5G technology and new innovative technologies for 6G and 7G. Millimeter-wave wireless communication has been introduced for 5G in addition to the conventional microwave. In this research projects, Tokyo Tech collaborates with related companies for developing wireless and IC technologies for the future 6G and 7G wireless service, especially focusing on low-power and low-post IC technology and satellite communication technology.

Members

Kenichi Okada, Prof. (Electrical & Electronic Eng., P.17)
Atsushi Shirane, Assoc. Prof. (Electrical & Electronic Eng. (FIRST, IIR), P.17)
Takashi Tomura, Assis. Prof. (Electrical & Electronic Eng., P.17)
Hiroyuki Sakai, Specially Appointed Prof.

Research and Development for Beyond 5G

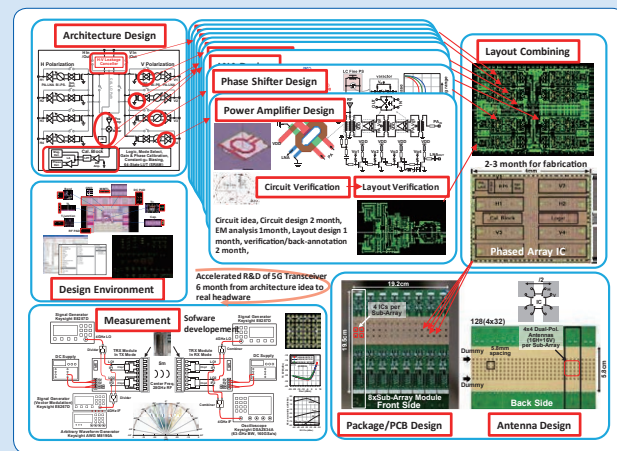

New Energy and Industrial Technology Development Organization (NEDO)

Next Generation Computing Technology

Technology Development of High Efficiency and High Speed Processing Distributed Computing System using Heterogeneous Material Integrated Optoelectronics

- 1) Large-scale photonic integrated circuit using heterogeneous material bonding technology
- 2) 10-Tbps-class, low power consumption (<10 pJ / bit) optical transceiver
- 3) Multi-degree elastic network architecture

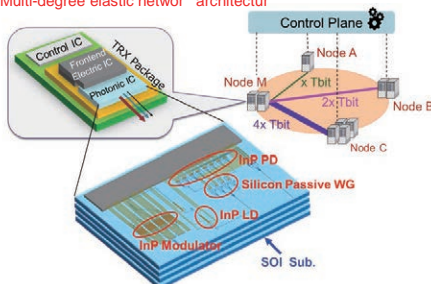

Research Overview

This project aims to realize the distributed computing system that efficiently connects regionally distributed computational resources (edge servers, etc.) as the next-generation computing technology.

To realize this, we are developing 10-Tbps-class photonic transceiver technology with low power consumption (<10 pJ / bit), which contains the photonic integrated circuit using heterogeneous semiconductor direct bonding technology, and the multi-degree elastic photonic network architecture.

This project will realize communication technology for next generation computing that can realize future large-scale metaverses.

Members

Nobuhiko Nishiyama, Prof. (Electrical&Elect. Eng., P.17)
Yuya Shoji, Assoc. Prof. (Electrical&Elect. Eng. (FIRST, IIR), P.17)
Tomohiro Amemiya, Asso. Prof. (Electrical&Elect. Eng. (FIRST, IIR) P.17)
Kensuke Ogawa, Specially Appointed Prof.(Electrical&Elect. Eng., P.17)
Tsuyoshi Horikawa, Specially Appointed Prof. (Electrical&Elect. Eng., P.17)
Yoshitaka Oiso, Spe.-Ap. Assoc. Prof. (Electrical&Elect. Eng., P.17)

Research Overview

Large-scale quantum computers may be useful to solve global social issues and challenges. In this study, we conduct research and development aimed at realizing a large-scale quantum computer in silicon, which is characterized by high integration and low power consumption. The semiconductor circuit integration technology makes silicon qubits advantageous for large-scale integration. Furthermore, they can be operated at higher temperatures than superconducting quantum computers, in principle. The goal of this study is to raise the operating temperature of qubits to around 1 Kelvin (from the usual 0.1 Kelvin). This will increase the cooling capacity of the refrigerator considerably, offering a solution to the problem of heat generation in the control and readout circuits that becomes more apparent with the size of the quantum computers increased to a practically useful level.

Members

Tetsuo Kodera, Assoc. Prof. (Electrical & Electronic Eng., P.18)
 Jun Yoneda, Specially Appointed Assoc. Prof. (Tokyo Tech Academy for Super Smart Society)

Elevating operation temperatures of silicon qubits towards large-scale silicon quantum computers

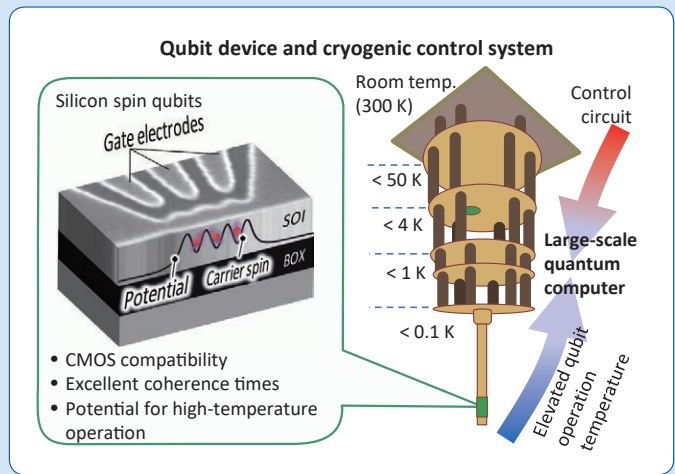

New Energy and Industrial Technology Development Organization (NEDO)

Collaborative Industry-Academia-Government R&D Project for Solving Common Challenges Toward Dramatically Expanded Use of Fuel Cells and Related Equipment

Development of non-destructive testing, on-line monitoring, and damage tolerance techniques to assure the integrity of high-pressure hydrogen storage tanks for fuel cell vehicles

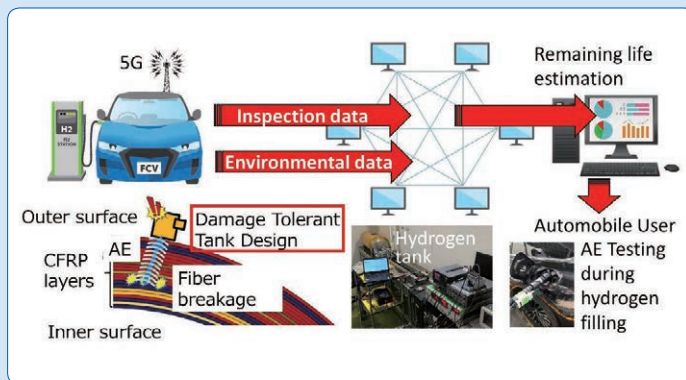

Research Overview

We are developing technologies to reduce the cost and extend the service life of high-pressure hydrogen storage tanks installed in fuel cell vehicles (FCVs), with the aim of further popularizing FCVs. Specifically, we are researching an online inspection technique to evaluate the integrity of the tanks using pressure increase that occur during hydrogen filling. We are also developing a damage tolerant low-cost tank design method based on this inspection. By utilizing the online inspection technology to be developed in this project and the communication function of a connected car, the integrity of tanks can be individually managed, enabling the tanks to be used until the end of their own service life. Several universities and national laboratories are participating in this project, the group leader of this project is our university.

Members

Yoshihiko Mizutani, Assoc. Prof. (Mech.Eng., P.12)
 Akira Todoroki, Prof. (Mech.Eng., P.11)

Japan Science and Technology Agency (JST) Moonshot R&D Project

Research and development on innovative earthwork operations

Research Overview

Targeting the construction of lunar bases and response to natural disasters such as river blockages, we are conducting research and development of a group of robots that can construct infrastructure while responding flexibly to changes in on-site conditions. The robots that combine shape adaptability and high power include (1) an elephant trunk power soft arm using hydraulic and pneumatic pressures, (2) a power soft gripper that grasps objects by entangling them like the tentacles of a sea anemone, and (3) multiple high-speed sandbags installed in the disaster site environment as a work mechanism for working in difficult-to-access areas. As work mechanisms for difficult-to-access areas, we are conducting research and development of (3) a parallel wire robot (Reelbot) that can transport earth and sand in a wide area at high speed by manipulating multiple wire jacks installed in the disaster site environment, and (4) a mechanism (Impactor) that moves by increasing friction force through high-speed driving with an inertial mass.

Members

Koichi Suzumori, Prof. (Mech.Eng., P.9)
 Gen Endo, Prof. (Mech.Eng., P.9)
 Hiroyuki Nabae, Ass. Prof. (Mech.Eng., P.10)

Collaborative AI robots for adaptation of diverse environments and innovation of infrastructure construction

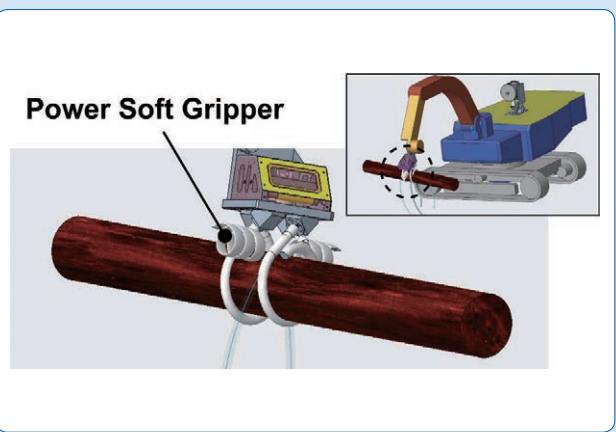

MIC, Research and Development for Expansion of Radio Resources Program

Research and Development of Time and Frequency Synchronization Technology with Mobile Atomic Clocks

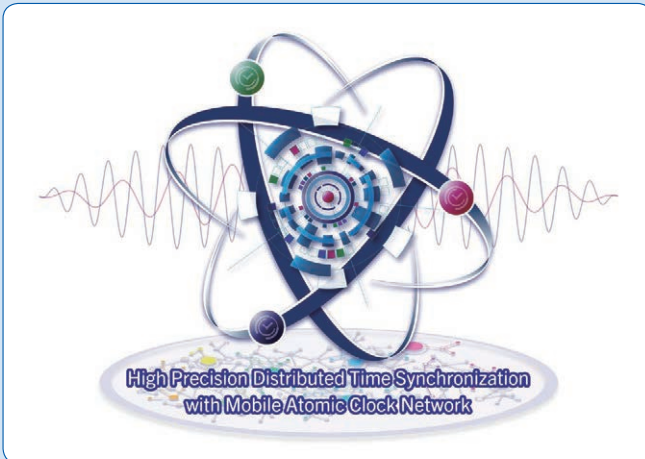

Research Overview

We aim at developing distributed time synchronization technology with a view to the widespread use of mobile atomic clock chips. Specifically, by making use of advanced systems and control theory, we develop a distributed algorithm that achieves precise time synchronization for a cluster of atomic clocks whose network structure changes from moment to moment.

Our algorithm will be validated in a testbed environment owned by National Institute of Information and Communications Technology (NICT), after which it will be implemented in actual equipment developed by two companies. Precise time synchronization using mobile atomic clock networks is expected to find a wide range of applications, including smart grids, financial transactions, broadcasting and automated driving.

Members

Takayuki Ishizaki, Assoc. Prof. (Syst. and Cont. Eng. P.14)

Research Project Promoted by Department of Industrial Engineering and Economics

Optimization Technology in Industrial Engineering and Economics

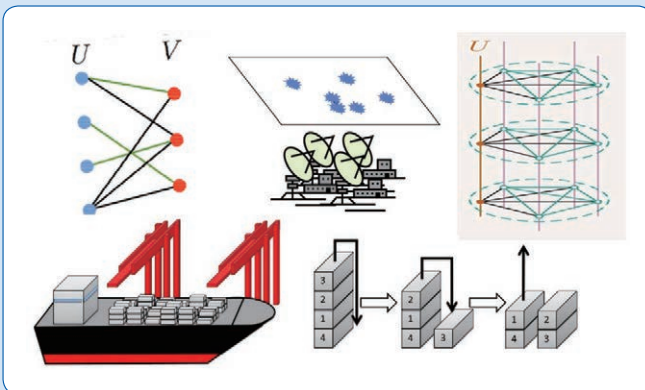

Research Overview

Various problems in practice are often written by a similar optimization model. For example, a problem to assign tasks in a factory to machines is called a matching problem, and a solution technique is used for assigning graduating medical students to their first hospital appointments and fusing databases with multiple sensors. It is known that facility location problems of fire departments have structures similar to those of electronic components location problems on electric circuit boards, container location problems at piers and distortion sensor location problems of buildings. Techniques for solving scheduling problems in the manufacturing industry are used for determining the delivery order of parcels and for determining the hole drilling order of electric circuit boards. The Analysis Method Creation Group aims to expand the scope of application as well as deepening the optimization theory.

Members

Tomomi Matsui, Prof. (Industrial Eng. & Econo., P.25)
Kazuhide Nakata, Prof. (Industrial Eng. & Econo., P.25)

Akiyoshi Shioura, Prof. (Industrial Eng. & Econo., P.25)

Selected Research Projects

MEXT, Doctoral Program for World-leading Innovative & Smart Education Tokyo Tech Academy for Super Smart Society

School of Engineering is leading Super Smart Society Promotion Project (SSS Promotion Consortium and WISE-SSS)!

Research Overview

School of Engineering is leading Tokyo Tech Super Smart Society (SSS) Promotion Project whose goal is to promote the realization of SSS, and to develop future leaders who are capable of leading the transformation to the new society. In October 2018, we established the SSS Promotion Consortium, and next generation education and research platform that fuses open education and open innovation in collaboration with consortium partners. We also launched the Doctoral Program for World-leading Innovative & Smart Education for SSS (WISE-SSS) to embody the open education in 2020 with a grant from the MEXT Doctoral Program for World-leading Innovative & Smart Education. Accordingly, we have established six SSS research and education fields as open innovation platforms for creating SSS.



Members

Tomohiko Uyematsu, Prof. (Info. and Com. Eng. P.22)
Kei Sakaguchi, Prof. (Electrical and Electronic Eng. P.17)
Kotaro Inoue, Prof. (Industrial Eng., P.25)

Eisuke Fukuda, Specially Appointed Prof.
Nobuyuki Iwatsuki, Prof. (Mech. Eng. P.12)
 70 faculties from various schools are participating!

MEXT project: Fostering value-creating professionals

Recurrent Education

Human resource development program to fostering value creation through synergy between technology and creativity

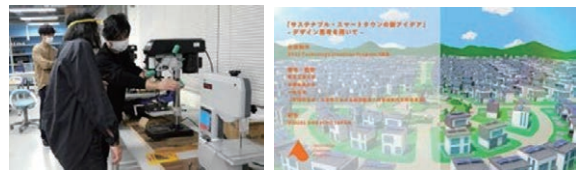

Research Overview

"Technology Creates Program" aims to develop a program for engineers and designers to acquire value creation skills and seize opportunities for social co-creation through the use of cutting-edge technology.

The six-month program for working professionals, in collaboration with Tama Art University and Hitotsubashi University, aims to cultivate the skills and build a network necessary for value-creating professionals through an all-round guidance system of technology, art and design, and business.

Members

Dai Senoo, Prof. (Industrial Eng. & Econo., P.26)
Shigeki Saito, Prof. (Mech. Eng., P.10)
Tohru Yagi, Prof. (Mech. Eng., P.10)
Kazuaki Inaba, Assoc. Prof. (Mech. Eng., P.12)

Momoko Nakatani, Assoc. Prof. (Info. and Com. Eng. P.21)
Hikaru Sakamoto, Assoc. Prof. (Mech. Eng., P.11)
Wataru Hijikata, Assoc. Prof. (Mech. Eng., P.12)

Collaborative Research Program on mobile communication system

Research Overview

In this course, we are conducting world-leading research to realize a "3D spatial cell construction covered ultra wide area"

This study is integrating the next-generation 5.5G/6G cellular network system that covers both ground and sky areas with the same frequency at each base station and HAPS cellular infrastructure, and consequently that network is available for a usual smart phone.

Members (*: Program Head)

Kei Sakaguchi, Prof. (EEE, P.17)*
Jiro Hirokawa, Prof. (EEE, P.17)
Tran Gia Khanh, Assoc. Prof. (EEE, P.17)
Teruya Fujii, S.A. Prof. (EEE, P.17)
Hideki Omote, S.A. Assoc. Prof. (EEE, P.17)

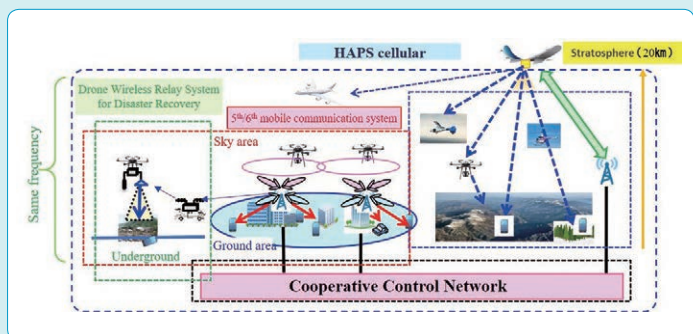

HRI-JP Next Generation Intelligent Communication and Social Interaction Research Alliance Laboratory (ICSI)

Research Overview

By combining the theories and technologies of robotics and artificial intelligence in the Systems and Control Systems of the School of Engineering with the technologies of intelligence, communication, and interaction in the Honda Research Institute Japan, we aim to conduct research on intelligent communication and social interaction in the next generation.



Members (*: Program Head)

Kazuhiro Nakadai, Prof. (SCE, P.15)*
Kenji Amaya, Prof. (SCE, P.15)
Jun-ichi Imura, Prof. (SCE, p.14)
Masatoshi Okutomi, Prof. (SCE, p.14)
Daisuke Kurabayashi, Prof. (SCE, P.15)
Hideyuki Tsukagoshi, Prof. (SCE, P.15)
Motomu Nakashima, Prof. (SCE, P.15)
Tomohisa Hayakawa, Prof. (SCE, p.14)
Katsutoshi Itoyama, S.A. Assoc. Prof. (SCE, P.15)

RICOH Collaborative Research Program on Advanced Digital Printing Technology

Increasing demand of digital printing technology (commercial and industrial)



Droplet deposition, coalescing, and image fixing

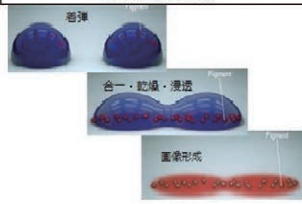

Inkjet printer (commercial and industrial)



Research Overview

The objective is to conduct basic research focusing on the elemental technologies that will become the core of next-generation digital printing technology and lead to high-speed, high-resolution imaging technology. In particular, research activities will focus on inkjet technology.

Members (*: Program Head)

Kazuyoshi Fushinobu, Prof. (ME, P.9)*
Katsunori Hanamura, Prof. (ME, P.10)
Takushi Saito, Assoc. Prof. (ME, P.10)

Tatsuya Kawaguchi, Asst. Prof. (ME, P.11)
Manabu Kodama, Asst. Prof. (ME, P.10)
Toshiaki Ougizawa, Prof. (MCT School)

Masami Kadonaga, S.A. Prof. (ME, P.9)
Koichi Kato, S.A. Assoc. Prof. (Lecturer) (ME, P.9)

JTEKT Collaborative Research Laboratory for Innovative Core Technology

Research Overview

Mission of this collaborative research laboratory is to conduct researches of fundamental technology developments that are important for next-generation machine elements, their application for robotic systems and high-performance factory management systems. Most important core issues of the lab are machinery elements (gears, bearings and feed screws) and AI-based analysis of voice signals.

Development of fundamental technologies for analysis, design and manufacturing of gears



Intelligent mobilities based on innovative machinery elements

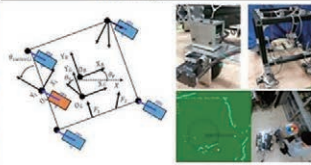

Development of noise-robust speech recognition techniques

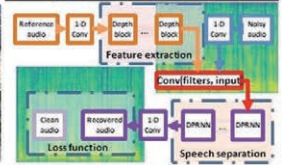

Members (*: Program Head)

Nobuyuki Iwatsuki, Prof. (ME, P.12)*
Yukio Takeda, Prof. (ME, P.9)
Takahiro Shinozaki, Assoc. Prof. (ICE, P.21)

Tsune Kobayashi, S.A. Prof. (ME, P.12)
Daisuke Matsuura, S. A. Assoc. Prof. (ME, P.12)

YASKAWA-TokyoTech Collaborative Research Chair

Expanding need for collaborative robots



Ultra-lightweight motor and actuator

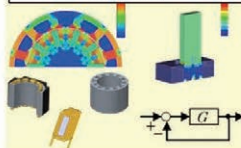

Exploration of new magnetic materials

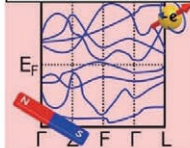

Synthesis and application of carbon materials

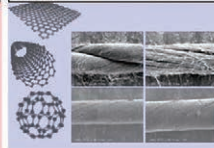

Research Overview

With the goal of realizing an ultralight collaborative robot in ten years, as a first step, we will bring together researchers in materials, motors, robotics, and other fields to study ultralight actuators to be used as a driving source.

Members (*: Program Head)

Akira Chiba, Prof. (EEE, P.19)*
Kyohei Kiyota, Assoc. Prof. (EEE, P.19)
Yusuke Sugahara, Assoc. Prof. (ME, P.9)

Yoshihiro Gohda, Assoc. Prof. (MCT School)
Shinsuke Mori, Assoc. Prof. (MCT School)
Tadahiko Shinshi, Prof. (IIR)

Hiroshi Nakamura, S.A. Prof. (EEE, P.19)
Mitsuru Endo, S.A. Assoc. Prof. (ME, P.9)

Collaborative Research Program on Power Electronics Fundamental Technology with Mitsubishi Electric Corp.

Research Overview

To contribute to society through innovation in power electronics equipment, we aim to strengthen fundamental technologies in collaboration with power electronics-related laboratories.

Members (*: Program Head)

Hideaki Fujita, Prof. (EEE, P.19)*
Makoto Hagiwara, Assoc. Prof. (EEE, P.19)
Kenichi Kawabe, Asst. Prof. (EEE, P.19)
Takahiro Urakabe, S.A. Prof. (EEE, P.19)
Shigeki Harada, S. A. Assoc. Prof. (EEE, P.19)

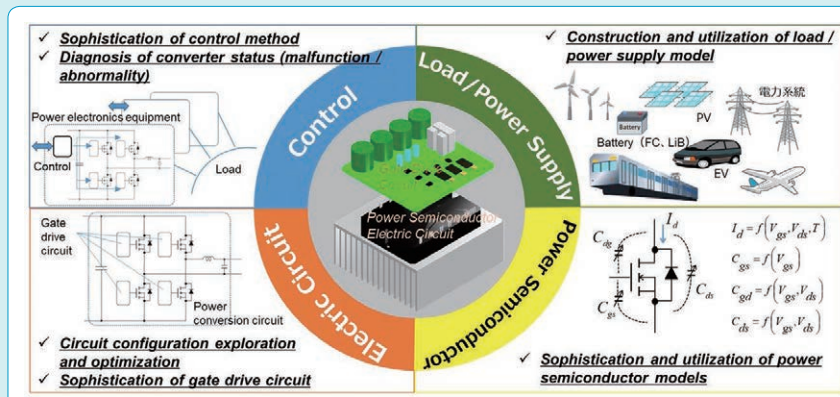

Other collaborative research laboratories and collaborative research clusters

- Collaborative Research Chair/Division Program founded by Sony Group Corporation
- DENSO Mobility Collaborative Research Cluster
- micware Future Navigation Collaborative Research Cluster

Abbreviations:

ME = Dept. of Mechanical Engineering

SCE = Dept. of Systems and Control Engineering

EEE = Dept. of Electrical and Electronic Engineering

ICE = Dept. of Information and Communications Engineering

IEE = Dept. of Industrial Engineering and Economics

MCT School = School of Materials and Chemical Technology

S.A. = Specially Appointed

(Ex.: S.A. Prof. = Specially Appointed Professor)

Industry Liaison

Large-scale Research Collaboration

	Collaborative Research Lectures	Collaborative Research Cluster	Schemes for Co-Creation of Education and Research
	Collaborative research among company, faculty and specially-appointed faculty members	Part of the Collaborative Research Cluster is placed within Tokyo Tech to conduct collaborative research	Company supervises lectures at Tokyo Tech along with conducting collaborative research
Collaborative research expenses (indirect expenses included/ space fee excluded)	> 30 million JPY per year	> 20 million JPY per year	> 10 million JPY per year
Specially-appointed faculty member ※1	Required (2 or more) Recommended by the company	Not required Can be recommended by the company	Not required
Contribution to education	Not required Student guidance by specially-appointed faculty members is possible	Not required	Required ※2 2 subjects for 4 or more credits in a year by specially-appointed faculty members,
Indirect expenses, etc.	Amount equivalent to 30% of direct expenses	Amount equivalent to 25% of direct expenses Expenses for strategic industry cooperation (15% or more of direct expenses) are separately required"	Amount equivalent to 30% of direct expenses
Period	More than 2 years and not more than 5 years	More than 3 years and not more than 10 years	More than 2 years and not more than 5 years
Dedicate space in Tokyo Tech	Not required	Required	Not required
Person responsible for the establishment	Head of department, etc.	Research base head (research representative)	Dean
Other information	Before establishment, collaborative research conducted together with faculty members received is required Application submission 5 months prior to the establishment"	Research planning team between company and Tokyo Tech Support from Tokyo Tech's Open Innovation Organization Application submission 3 months prior to the establishment"	Lectures and collaborative research are based on the same topics Application submission 3 months prior to the establishment"

※1 Specially-appointed faculty members are hired by collaborative research expenses

※2 Lectures will be incorporated into the special study programs set for the schools established at Tokyo Tech

“Technical Exchange”

We propose “Technical Exchange” to provide free-discussion opportunity for future full-collaborative research.

Send an inquiry to Industry-University Cooperation Office at School of Engineering

- Refinement of discussion points in advance
- Discussion between members from company and Tokyo Tech in School of Engineering
- Research introduction and discussion on the topics from faculty members
- Discussion place can be either company or Tokyo Tech

*** We recommend to conclude an academic teaching agreement to join the “Technical Exchange”**

- Secure the confidentiality by NDA
- All the faculty members in School of Engineering will follow the agreement
- An expense of about 1M JPY per year for “Technical Exchange” on regular basis

Seminar of technical seeds

Introduction of research seeds of about 200 faculty members in School of Engineering

- Research topic from the standpoint of industry
- Topics related to many company, hot topics and theme

About 2 seminars per year

- Example: Heat transfer engineering, Integrated IoT, Management engineering, Acoustic engineering

Use the chance for personal connection to faculty members

- Collaborative research, Joint proposal for funding agency
- Technical advisor, in-company training, etc.

Inquiry for collaborative research with faculty members at School of Engineering

Tokyo Institute of Technology

Ookayama campus: 2-12-1 Ookayama, Meguro-ku, Tokyo 152-8550

Suzukakedai campus: 4259 Nagatsuta, Midori-ku, Yokohama, Kanagawa 226-8503

Industry-University Cooperation Office

(Ookayama campus, Ishikawadai 5 bld. 3F, room 304)

URL: <http://icu-seng.e.titech.ac.jp> E-mail: icu-seng@e.titech.ac.jp

or

Office of Research and Innovation

URL: <https://www.ori.titech.ac.jp/en/> E-mail: sangaku@sangaku.titech.ac.jp

Statistics

Number of Staff

(As of May 1 2022)

Course	Professor	Associate Professor	Associate Professor (Lecturer)	Assistant Professor	Total
Department of Mechanical Engineering	26	20	1	14	61
Department of Systems and Control Engineering	10	10		7	27
Department of Electrical and Electronic Engineering	13	18		11	42
Department of Information and Communications Engineering	12	11		9	32
Department of Industrial Engineering and Economics	8	9		6	23
Total	69	68	1	47	185

Number of Students

(As of May 1 2022)

Undergraduate Course

Department	1st year		2nd year		3rd year		4th year		Total		Total								
	Men	Women	Men	Women	Men	Women	Men	Women	International Student	International Student									
Department of Mechanical Engineering			119	2	5	1	130	7	8	1	151	11	9	0	422	22			
Department of Systems and Control Engineering			43	2	6	0	42	2	7	2	54	2	5	0	157	8			
Department of Electrical and Electronic Engineering	355	12	31	2	86	3	5	0	89	5	7	5	105	6	6	1	298	20	
Department of Information and Communications Engineering					48	2	2	0	46	4	6	1	56	1	2	1	160	9	
Department of Industrial Engineering and Economics					51	0	7	0	49	1	14	1	76	2	3	0	200	4	
Total	355	12	31	2	347	9	25	1	356	19	42	10	442	22	25	2	1237	63	1623

(As of May 1 2022)

Master's Course

Department	1st year		2nd year		Total					
	Men	Women	Men	Women	International Student	International Student				
Department of Mechanical Engineering										
Graduate Major in Mechanical Engineering	138	19	8	2	138	10	11	3	295	34
Graduate Major in Energy Science and Engineering	20	2	1	1	13	1	0	0	34	4
Graduate Major in Engineering Sciences and Design	10	2	3	0	16	4	2	0	31	6
Graduate Major in Human Centered Science and Biomedical Engineering	13	2	2	1	14	1	3	0	32	4
Graduate Major in Nuclear Engineering	3	0	0	0	7	1	0	0	10	1
Subtotal	184	25	14	4	188	17	16	3	402	49
Department of Systems and Control Engineering										
Graduate Major in Systems and Control Engineering	68	12	4	3	62	12	8	1	142	28
Graduate Major in Engineering Sciences and Design	1	0	0	0	0	0	0	0	1	0
Subtotal	69	12	4	3	62	12	8	1	143	28
Department of Electrical and Electronic Engineering										
Graduate Major in Electrical and Electronic Engineering	133	26	10	6	140	36	17	9	300	77
Graduate Major in Energy Science and Engineering	15	0	2	2	17	1	1	1	35	4
Graduate Major in Human Centered Science and Biomedical Engineering	11	2	2	1	12	0	1	1	26	4
Graduate Major in Nuclear Engineering	3	0	0	0	6	0	0	0	9	0
Subtotal	162	28	14	9	175	37	19	11	370	85
Department of Information and Communications Engineering										
Graduate Major in Information and Communications Engineering	90	37	19	10	89	31	22	16	220	94
Graduate Major in Human Centered Science and Biomedical Engineering	1	0	4	3	3	1	1	1	9	5
Subtotal	91	37	23	13	92	32	23	17	229	99
Department of Industrial Engineering										
Graduate Major in Industrial Engineering and Economics	55	9	15	8	58	4	15	5	143	26
Graduate Major in Engineering Sciences and Design	1	0	0	0	0	0	0	0	1	0
Subtotal	56	9	15	8	58	4	15	5	144	26
Total	562	111	70	37	575	102	81	37	1288	287

Interdisciplinary Graduate Majors	1st year		2nd year		Total					
	Men	Women	Men	Women	International Student	International Student				
Graduate Major in Energy Science and Engineering	84	13	16	9	69	8	9	6	178	36
Graduate Major in Engineering Sciences and Design	32	8	9	2	30	6	5	1	76	17
Graduate Major in Human Centered Science and Biomedical Engineering	61	9	34	14	78	14	37	14	210	51
Graduate Major in Nuclear Engineering	41	9	8	5	42	4	8	4	99	22
Graduate Major in Artificial Intelligence	67	22	8	4	63	18	16	9	154	53
Graduate Major in Urban Design and Built Environment	38	4	23	4	55	10	29	7	145	25

Doctoral Course

(As of May 1 2022)

Department	1st year		2nd year		3rd year		Total							
	Men	Women	Men	Women	Men	Women								
	International Student	International Student	International Student	International Student	International Student	International Student	International Student	International Student						
Department of Mechanical Engineering														
Graduate Major in Mechanical Engineering	18	9	2	2	27	16	2	1	35	13	5	2	89	43
Graduate Major in Energy Science and Engineering	2	2	1	1	2	2	0	0	2	1	1	1	8	7
Graduate Major in Engineering Sciences and Design	2	1	0	0	0	0	0	0	3	0	1	1	6	2
Graduate Major in Human Centered Science and Biomedical Engineering	2	0	0	0	2	1	0	0	2	2	0	0	6	3
Graduate Major in Nuclear Engineering	0	0	0	0	0	0	0	0	2	1	1	1	3	2
Subtotal	24	12	3	3	31	19	2	1	44	17	8	5	112	57
Department of Systems and Control Engineering														
Graduate Major in Systems and Control Engineering	10	5	0	0	9	3	2	2	12	5	0	0	33	15
Graduate Major in Engineering Sciences and Design	0	0	0	0	0	0	0	0	0	0	0	0	0	0
Subtotal	10	5	0	0	9	3	2	2	12	5	0	0	33	15
Department of Electrical and Electronic Engineering														
Graduate Major in Electrical and Electronic Engineering	35	20	2	2	30	14	1	1	49	27	6	6	123	70
Graduate Major in Energy Science and Engineering	4	1	0	0	2	0	1	1	0	0	0	0	7	2
Graduate Major in Human Centered Science and Biomedical Engineering	1	0	0	0	3	2	0	0	4	0	0	0	8	2
Graduate Major in Nuclear Engineering	0	0	0	0	0	0	0	0	1	1	0	0	1	1
Subtotal	40	21	2	2	35	16	2	2	54	28	6	6	139	75
Department of Information and Communications Engineering														
Graduate Major in Information and Communications Engineering	24	14	2	2	13	7	4	2	33	16	6	6	82	47
Graduate Major in Human Centered Science and Biomedical Engineering	3	3	0	0	4	3	1	1	5	3	2	1	15	11
Subtotal	27	17	2	2	17	10	5	3	38	19	8	7	97	58
Department of Industrial Engineering														
Graduate Major in Industrial Engineering and Economics	5	2	0	0	5	0	1	1	9	3	3	2	23	8
Graduate Major in Engineering Sciences and Design	0	0	0	0	0	0	0	0	0	0	0	0	0	0
Subtotal	5	2	0	0	5	0	1	1	9	3	3	2	23	8
Total	106	57	7	7	97	48	12	9	157	72	25	20	404	213

Interdisciplinary Graduate Majors	1st year		2nd year		3rd year		Total							
	Men	Women	Men	Women	Men	Women								
	International Student	International Student	International Student	International Student	International Student	International Student	International Student	International Student						
Graduate Major in Energy Science and Engineering	24	8	2	2	21	9	2	1	13	5	2	2	64	27
Graduate Major in Engineering Sciences and Design	2	1	1	1	1	0	0	0	5	1	2	1	11	4
Graduate Major in Human Centered Science and Biomedical Engineering	20	7	13	13	20	9	10	7	29	15	11	8	103	59
Graduate Major in Nuclear Engineering	13	9	0	0	7	1	3	2	16	4	3	1	42	17
Graduate Major in Artificial Intelligence	22	13	4	4	13	6	2	1	32	11	12	5	85	40
Graduate Major in Urban Design and Built Environment	10	3	10	9	6	4	3	0	21	7	12	6	62	29

Research Funds

(As of December 2022)

Year	Number of Projects	Research Fund (in thousand yen)
2017	51	910,291
2018	72	1,712,631
2019	54	1,620,301
2020	49	1,628,405
2021	63	1,827,572
2022	61	3,491,476
Total	350	7,699,200

Grant-in-Aid for Scientific Research 2022

(As of January 2023)

Subject for Research	Number of Adoption	Amount (in thousand of yen)
Grant-in-Aid for Scientific Research (A)	23	114,887
Grant-in-Aid for Scientific Research (B)	62	204,689
Grant-in-Aid for Scientific Research (C)	43	43,711
Grant-in-Aid for Scientific Research (S)	2	50,490
Grant-in-Aid for Early-Career Scientists	19	29,770
Grant-in-Aid for Scientific Research on Innovative Areas	5	77,610
Grant-in-Aid for Challenging Research (Pioneering) / (Exploratory)	11	22,250
Grant-in-Aid for Research Activity start-up	5	7,280
Fund for the Promotion of Joint International Research (Fostering Joint International Research (A)・(B))	3	27,053
Grant-in-Aid for Transformative Research Areas(A)	4	26,939
Total	177	604,679

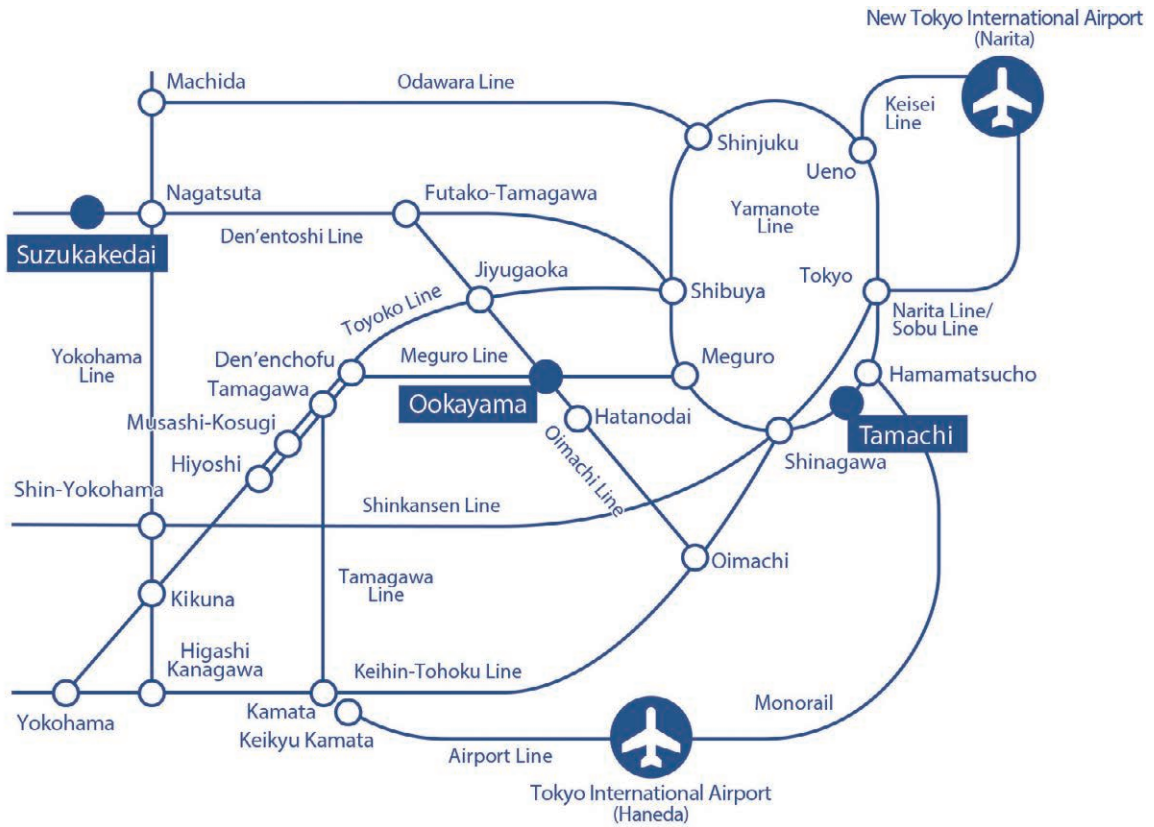

Ookayama Campus is
Suzukakedai Campus is
Tamachi Campus is

a 1-minute walk from Ookayama Station
 a 5-minute walk from Suzukakedai Station
 a 2-minute walk from Tamachi Station

Location

Ookayama Campus

2-12-1 Ookayama, Meguro-ku, Tokyo 152-8550, Japan

Suzukakedai Campus

4259 Nagatsuta-cho, Midori-ku, Yokohama, Kanagawa 226-8503, Japan